

AT-TQ6602

Enterprise-class 802.11ax Indoor Wireless Access Point
with 2.4GHz and 5GHz Radios

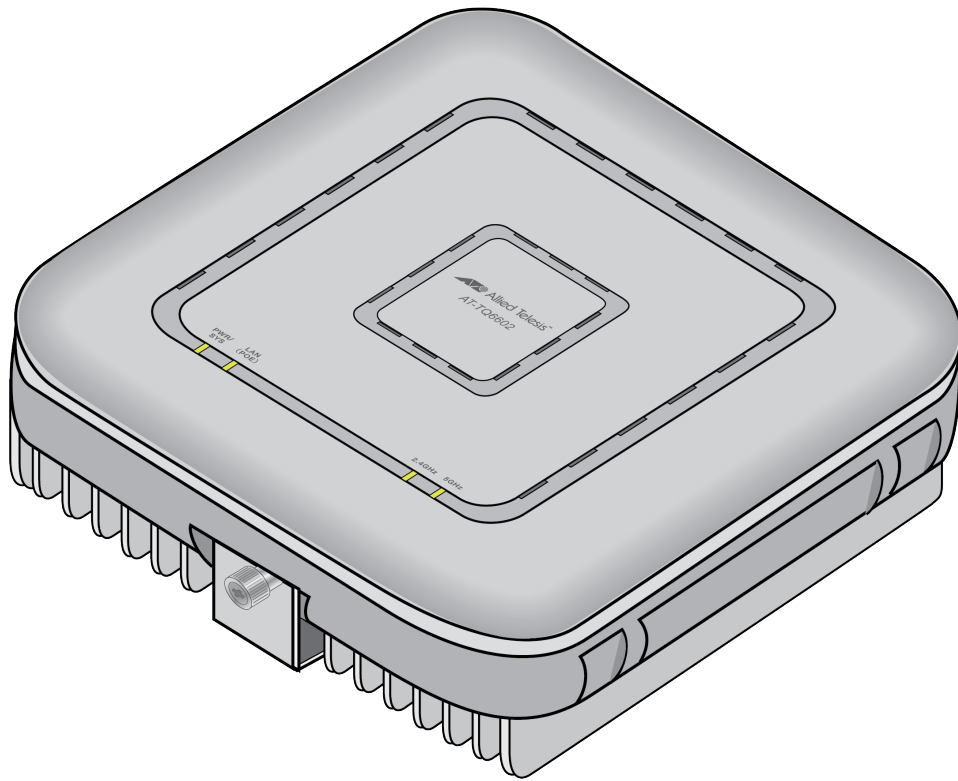

Installation Guide

Copyright © 2021 Allied Telesis, Inc.

All rights reserved. No part of this publication may be reproduced without prior written permission from Allied Telesis, Inc.

Allied Telesis and the Allied Telesis logo are trademarks of Allied Telesis, Incorporated. All other product names, company names, logos or other designations mentioned herein are trademarks or registered trademarks of their respective owners.

Allied Telesis, Inc. reserves the right to make changes in specifications and other information contained in this document without prior written notice. The information provided herein is subject to change without notice. In no event shall Allied Telesis, Inc. be liable for any incidental, special, indirect, or consequential damages whatsoever, including but not limited to lost profits, arising out of or related to this manual or the information contained herein, even if Allied Telesis, Inc. has been advised of, known, or should have known, the possibility of such damages.

Electrical Safety and Emissions Standards

This product meets the following standards:

- ❑ “Federal Communications Commission Interference Statement”
- ❑ “European Union Restriction of the Use of Certain Hazardous Substances (RoHS) in Electrical and Electronic Equipment” on page 4
- ❑ “Safety and Electromagnetic Emissions” on page 4
- ❑ “Translated Safety Statements” on page 8

Federal Communications Commission Interference Statement

Declaration of Conformity

Manufacturer Name: **Allied Telesis**

Declares that the product: **802.11ax 4x4+4x4 dual radio 2.4G/5G wireless access point**

Model Number: **AT-TQ6602**

This device complies with Part 15 of the FCC Rules. Operation is subject to the following two conditions: (1) This device may not cause harmful interference, and (2) this device must accept any interference received, including interference that may cause undesired operation.

This equipment has been tested and found to comply with the limits for a Class B digital device, pursuant to Part 15 of the FCC Rules. These limits are designed to provide reasonable protection against harmful interference in a residential installation. This equipment generates, uses and can radiate radio frequency energy and, if not installed and used in accordance with the instructions, may cause harmful interference to radio communications. However, there is no guarantee that interference will not occur in a particular installation. If this equipment does cause harmful interference to radio or television reception, which can be determined by turning the equipment off and on, the user is encouraged to try to correct the interference by one of the following measures:

- Reorient or relocate the receiving antenna.
- Increase the separation between the equipment and receiver.
- Connect the equipment into an outlet on a circuit different from that to which the receiver is connected.
- Consult the dealer or an experienced radio/TV technician for help.

**Caution**

FCC Caution: Any changes or modifications not expressly approved by the party responsible for compliance could void the user's authority to operate this equipment. ⚡ E80

**Avertissement**

Avertissement de la FCC: Les changements ou modifications non expressément approuvés par la partie responsable de la conformité pourraient annuler l'autorité de l'utilisateur à utiliser cet équipement. ⚡ E80

This transmitter must not be co-located or operating in conjunction with any other antenna or transmitter.

Radiation Exposure Statement:

This equipment complies with FCC radiation exposure limits set forth for an uncontrolled environment. This equipment should be installed and operated with minimum distance 20 cm between the radiator & your body.

European Union Restriction of the Use of Certain Hazardous Substances (RoHS) in Electrical and Electronic Equipment

This Allied Telesis RoHS-compliant product conforms to the European Union Restriction of the Use of Certain Hazardous Substances (RoHS) in Electrical and Electronic Equipment. Allied Telesis ensures RoHS conformance by requiring supplier Declarations of Conformity, monitoring incoming materials, and maintaining manufacturing process controls.

Note

For additional regulatory statements, refer to Appendix B, "Regulatory Statements" on page 75.

Safety and Electromagnetic Emissions

Standard Compliance

- RoHs compliant
- European Union RoHS (Directive 2011/65/EU of the European Parliament and of the Council of 8 June 2011 on the restriction of the use of certain hazardous substances in electrical and electronic equipment.)

Wire Communication

- IEEE 802.1
- IEEE 802.3
- IEEE 802.3u
- IEEE 802.3z
- IEEE 802.3ab
- IEEE 802.3bz
- IEEE 802.3x
- IEEE 802.3at
- ITU-T G.993.1

Wireless LAN Communication

- IEEE 802.11 DSSS
- IEEE 802.11a OFDM
- IEEE 802.11b DSSS/FHSS
- IEEE 802.11g OFDM
- IEEE 802.11n OFDM
- IEEE 802.11ac OFDM
- IEEE 802.11ax OFDMA

Safety

- CB/UL
 - IEC 62368-1
 - UL 62368-1
 - CSA C22.2 No. 62368-1
 - IEC 60950-1
- TUV
 - EN62368-1 (Co-license)
- UL2043

Electro Magnetic Interference (EMI)

- FCC part15 Subpart B/ Class B
- EN55032 Class B
- VCCI-CISPR 32 / Class B
- AS/NZS CISPR 32

Electro Magnetic Susceptibility (EMS) - EN55024 and EN55035

- IEC 61000-4-2
- IEC 61000-4-3
- IEC 61000-4-4
- IEC 61000-4-5
- IEC 61000-4-6
- (IEC 61000-4-8
- IEC 61000-4-11
- IEC 61000-3-2
- IEC 61000-3-3

FCC

- 47 CFR Part15, subpart C
- 47 CFR Part15, subpart E
- DFS

CE

- RED Directive 2014/53/EU
- EN55032
- EN 55024
- EN 301489-1 V2.1.1
- EN 301489-17 V3.1.1
- EN 300328 V2.2.2
- EN 301893 V2.1.1
- EN 62311 / EN 50385
- European Council Directive 2014/30/EU
- DFS
- EN 55035
- EN 60601-1-2

RCM

- AS/NZS CISPR 32
- AS/NZS 4268

IC

- ICES-003 issue 6
- RSS-102
- RSS-247 issue 2

Japan

- JATE
- ARIB STD-T66
- ARIB STD-T71

Hong Kong OFCA

India WPC

Malaysia SIRIM

Singapore IMDA TS SRD



Figure 1. Singapore IMDA Logo

Taiwan BSMI & NCC

Thailand NBTC

Vietnam MIC

China SRRC

Translated Safety Statements

Important: The  indicates that a translation of the safety statement is available in a PDF document titled *Translated Safety Statements* on the Allied Telesis website at www.alliedtelesis.com/library.

Remarque: Les consignes de sécurité portant le symbole  sont traduites dans plusieurs langues dans le document *Translated Safety Statements*, disponible à l'adresse www.alliedtelesis.com/library.

Contents

Preface	15
Safety Symbols Used in this Document	16
Contacting Allied Telesis	17
Chapter 1: Product Description	19
Features	20
Hardware Components	23
Ethernet LAN Port	25
Power Over Ethernet	25
Connector Type	25
Speed	25
Duplex Mode	26
Automatic MDIX Detection	26
Cable Requirements	27
Maximum Distance	27
Port Pinouts	27
How to Power the Wireless Access Point	28
External AC/DC Power Adapter	28
PoE+ Power Source	28
Both AC/DC Power Adapter and PoE Power Source	29
DC Connector for an External AC/DC Power Adapter	30
POWER On/Off Button	31
LEDs	32
Reset Button	34
Management Tools	35
Web Browser	35
Vista Manager EX and AWC Plug-in	35
SNMP	35
Chapter 2: Beginning the Installation	37
Reviewing Safety Precautions	38
Choosing a Site for the Wireless Access Point	41
Unpacking the Shipping Box	42
Chapter 3: Installing the Wireless Access Point	43
Installing the Wireless Access Point on a Table	44
Overview to Installing the Wireless Access Point on a Wall or Ceiling	48
Installing the Mounting Bracket on a Wall or Ceiling	51
Installing the Mounting Bracket Screws	55
Connecting an Ethernet Cable to the Ethernet LAN Port	56
Connecting the AC/DC Power Adapter	57
Attaching the Wireless Access Point to the Wall Mounting Bracket	59
Installing an Anti-theft Device	61
Chapter 4: Managing the Wireless Access Point	63
Starting the First Management Session Without a DHCP Server	64
Starting the First Management Session with a Direct Connection	65
Starting the First Management Session Over a Network	65
Starting a Management Session	67

Appendix A: Technical Specifications	69
Physical Specifications	69
Environmental Specifications	69
Power Specifications	70
Input Power Specifications	70
External AC/DC Power Adapter Specifications	70
PoE+ Power Requirements	70
Cable Specifications	71
LAN Ports Specifications and Pinouts	72
Port Specifications	72
Port Pinouts	72
Appendix B: Regulatory Statements	75
Federal Communication Commission Interference Statement	76
Industry Canada Statement	78
Europe - EU Declaration of Conformity	80
Operating Frequencies and Maximum Transmission Power Levels	80
Radiation Exposure Statement	80
Importer	80
UK - UKCA Declaration of Conformity	81
Operating Frequencies and Maximum Transmission Power Levels	81
Radiation Exposure Statement	81
Importer	81
Appendix C: Radiation Patterns	83
2.4GHz Antenna 1	84
2.4GHz Antenna 2	87
2.4GHz Antenna 3	90
2.4GHz Antenna 4	93
5GHz Antenna 1	96
5GHz Antenna 2	99
5GHz Antenna 3	102
5GHz Antenna 4	105

Figures

Figure 1: Singapore IMDA Logo	7
Figure 2: Top View	23
Figure 3: Front Panel	24
Figure 4: Rear Panel	24
Figure 5: Powering the Access Point with an AC/DC Power Adapter	28
Figure 6: Powering the Access Point with a PoE Power Source	28
Figure 7: Powering the Access Point with Both an External AC/DC Adapter and a PoE+ Power Source	29
Figure 8: PWRADP-01 Power Adapter	30
Figure 9: Shipping Box Contents	42
Figure 10: TQ6602 Wireless Access Point on a Table	44
Figure 11: Installing the Bracket Screws	45
Figure 12: Panel Screws	45
Figure 13: Installing the Mounting Bracket	46
Figure 14: Tightening Bracket Retaining Screw	46
Figure 15: Orientations of the TQ6602 Wireless Access Point on a Wall	48
Figure 16: Invalid Position of the TQ6602 Wireless Access Point on a Wall	48
Figure 17: TQ6602 Wireless Access Point on the Ceiling	49
Figure 18: Marking the Holes for the Key-Hole Slots	51
Figure 19: Installing Two Screws	52
Figure 20: Installing the Wall Mounting Bracket On the Screws	53
Figure 21: Pre-Drill Holes on Wall Mounting Bracket	53
Figure 22: Securing the Wall Mounting Bracket	54
Figure 23: Installing the Bracket Screws into the Wireless Access Point	55
Figure 24: Connecting an Ethernet Cable to the LAN Port	56
Figure 25: Connecting the AC Power Cord to the PWRADP-01 Power Adapter	57
Figure 26: Connecting an AC/DC Power Adapter to the DC IN Connector	57
Figure 27: Connecting the Power Cord on the PWRADP-01 Power Adapter to an AC Source	58
Figure 28: DC Power On/Off Button	58
Figure 29: Installing the Wireless Access Point on the Wall Mounting Bracket	59
Figure 30: Seating the Wireless Access Point on the Wall Mounting Bracket	60
Figure 31: Tightening the Wall Mounting Bracket Thumbscrew	60
Figure 32: Kensington Lock Port	61
Figure 33: Log On Window	67
Figure 34: Pin Layout for RJ45 Connector on the Ethernet Port	72

Tables

Table 1. LED Status Information	32
Table 2. Physical Specifications	69
Table 3. Environmental Specifications	69
Table 4. Input Power Specifications	70
Table 5. External AC/DC Power Adapter Specifications	70
Table 6. PoE Power Requirements on the Ethernet Port	70
Table 7. LAN Port Specifications	72
Table 8. MDI Pin Signals at 10/100Mbps	72
Table 9. MDIX Pin Signals at 10/100Mbps	73
Table 10. Connector Pinouts at 1/2.5/5Gbps	73

Preface

This guide contains the hardware installation instructions for the indoor IEEE802.11ax TQ6602 Wireless Access Point. The preface contains the following sections:

- “Safety Symbols Used in this Document” on page 16
- “Contacting Allied Telesis” on page 17

Safety Symbols Used in this Document

This document uses the following conventions.

Note

Notes provide additional information.



Caution

Cautions inform you that performing or omitting a specific action may result in equipment damage or loss of data.



Warning

Warnings inform you that performing or omitting a specific action may result in bodily injury.



Warning

Warnings inform you of hot surfaces.

Contacting Allied Telesis

For assistance with this product, you can contact Allied Telesis technical support by going to the Support & Services section of the Allied Telesis web site at **www.alliedtelesis.com/support**. You can find links for the following services on this page:

- ❑ 24/7 Online Support — Enter our interactive support center to search for answers to your product questions in our knowledge database, check support tickets, learn about Return Merchandise Authorizations (RMAs), and contact Allied Telesis technical experts.
- ❑ USA and EMEA phone support — Select the phone number that best fits your location and customer type.
- ❑ Hardware warranty information — Learn about Allied Telesis warranties and register your product online.
- ❑ Replacement Services — Submit an RMA request via our interactive support center.
- ❑ Documentation — View the most recent installation and user guides, software release notes, white papers, and data sheets for your products.
- ❑ Software Downloads — Download the latest software releases for your managed products.

For sales or corporate information, go to **www.alliedtelesis.com/purchase**.

Chapter 1

Product Description

The sections in this chapter describe the hardware components of the 802.11ax TQ6602 Wireless Access Point:

- ❑ “Features” on page 20
- ❑ “Hardware Components” on page 23
- ❑ “Ethernet LAN Port” on page 25
- ❑ “How to Power the Wireless Access Point” on page 28
- ❑ “DC Connector for an External AC/DC Power Adapter” on page 30
- ❑ “POWER On/Off Button” on page 31
- ❑ “LEDs” on page 32
- ❑ “Reset Button” on page 34
- ❑ “Management Tools” on page 35

Features

Hardware features include:

- One 2.4GHz radio
- One 5GHz radio
- 4x4 MU-MIMO 2.4GHz Internal antennas
- 4x4 MU-MIMO 5GHz Internal antennas
- Transmission beamforming
- One 10/100Mbps/1/2.5/5Gbps Ethernet LAN port with RJ-45 connector
- IEEE 802.3at PoE+ Class 4 powered device
- One Reset button for restoring the default settings
- One On/Off button for the AC/DC power adapter connector
- LEDs for the 2.4GHz and 5GHz radios, Ethernet LAN port, and power
- Ceiling, wall, or table installation
- Kensington lock port
- One Console RJ-45 port for factory use only

Software features include:

- IEEE802.11a/b/g/n/ac/ax
- Multi-channel (cell operation)
- Channel Blankets (single-channel operation)
- Multi-channel and Channel Blanket hybrid operation
- Orthogonal Frequency Division Multiple Access (OFDMA)
- Manual or automatic radio channel selection
- Sixteen virtual access points (VAPs) per radio and thirty-two VAPs per access point
- Quality of Service (QoS) ingress and egress queues
- Fast roaming (IEEE 802.11v/k/r)
- Control of radio transmission power
- Dynamic frequency selection
- Band steering
- WiFi multimedia (WMM) for prioritizing traffic
- Client filtering by MAC addresses with on-board filter
- Wireless Distribution System (WDS) bridges

- Dynamic Host Control Protocol (DHCP) client
- Network Time Protocol (NTP) client
- System log
- Syslog client
- Autonomous Management Framework (AMF) Guest node

Security and encryption include:

- Open system
- Shared key authentication
- Static WEP with 64/128/256 bit encryption (IEEE 802.11a/b/g only)
- WPA Personal or Enterprise security with auto, CCMP (AES), or TKIP encryption
- WPA2 Personal or Enterprise security with auto, CCMP (AES), or TKIP encryption
- WPA3 Personal or Enterprise security with CCMP (AES/CNSA) encryption

Frequency range and bandwidth for the 2.4GHz radio include:

- 2.412 to 2.484GHz
- 20/40MHz

Frequency range and bandwidth for the 5GHz radio include:

- 5.150 to 5.850GHz
- 20/40/80/80+80MHz

Features of the Ethernet LAN port include:

- 10Mbps (IEEE 802.3), 100Mbps (IEEE 802.3u), 1000Mbps (IEEE 802.3ab), 2.5Gbps, and 5Gbps (IEEE 802.3bz)
- PoE+ (IEEE 802.3at)
- Flow control (IEEE 802.3x)
- VLAN tagging (IEEE 802.1Q)
- Auto-Negotiation for speed and duplex mode
- Auto-MDI/MDIX at 10/100Mbps

Management options include:

- On-board web browser management interface
- Vista Manager EX with Automous Wave Controller (AWC) plug-in or AWC lite plug-in

- ❑ Autonomous Management Framework (AMF) Security or Security Mini (AMF-Sec mini)
- ❑ SNMPv1 and v2c

Note

For a complete list of features, refer to the *TQ6602 Wireless Access Point User Guide* or the product's data sheet.

Hardware Components

The top view of the TQ6602 Wireless Access Point is illustrated in Figure 1.

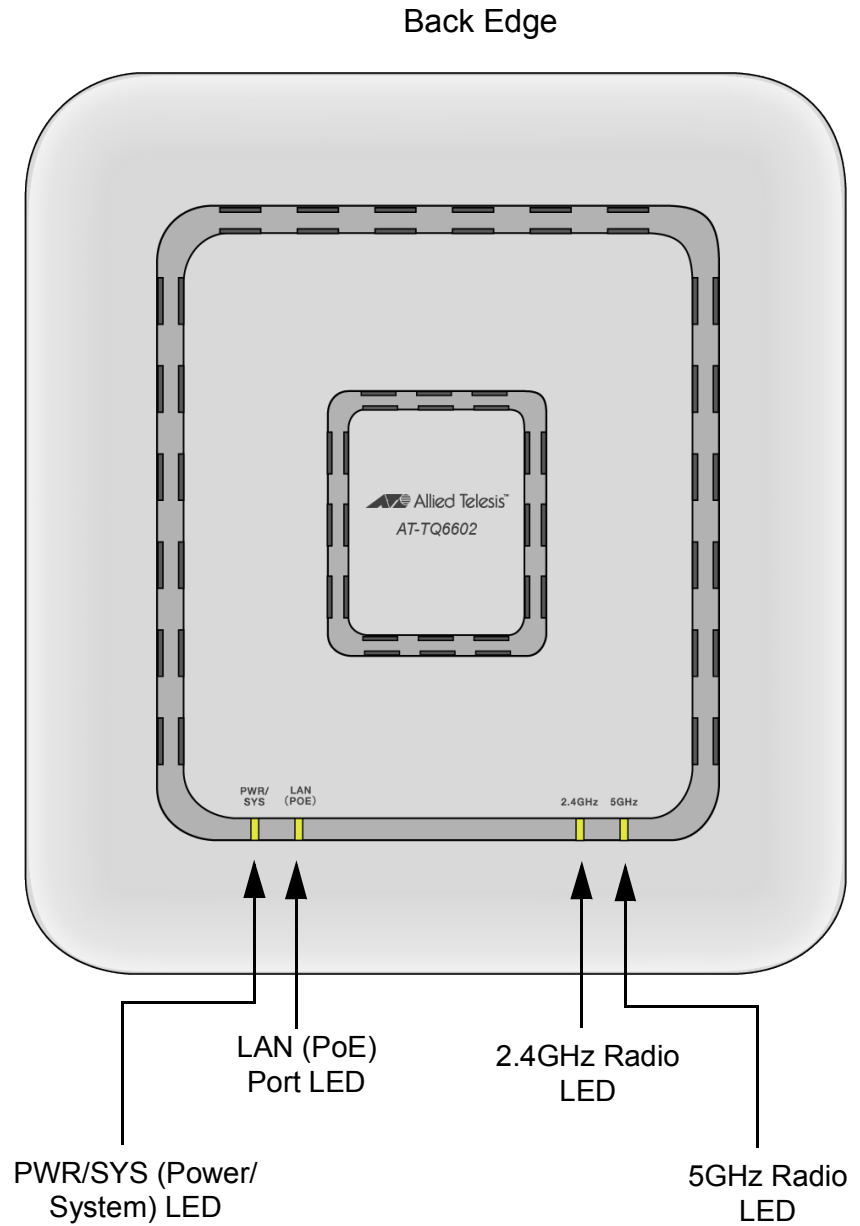

Figure 1. Top View

The front panel is illustrated in Figure 2.

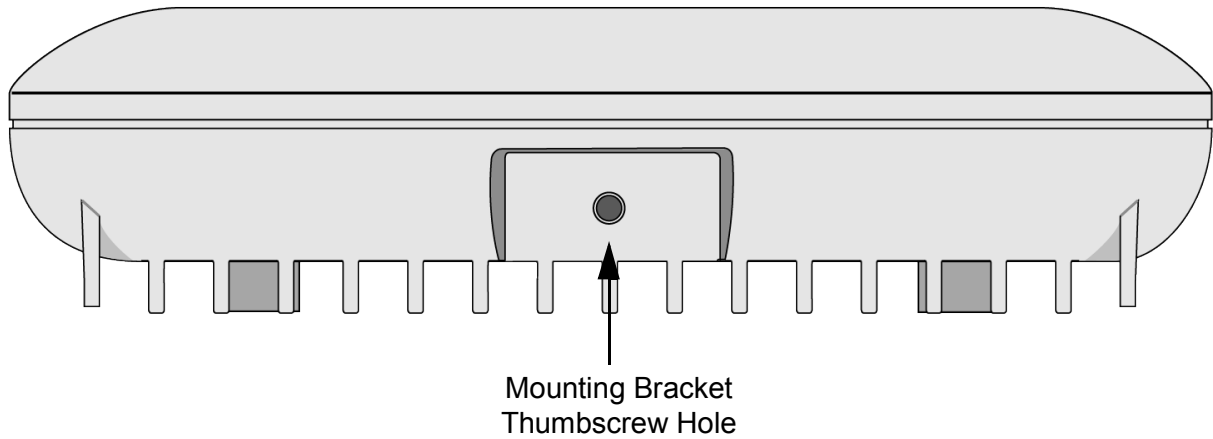

Figure 2. Front Panel

The rear panel is shown in Figure 3.

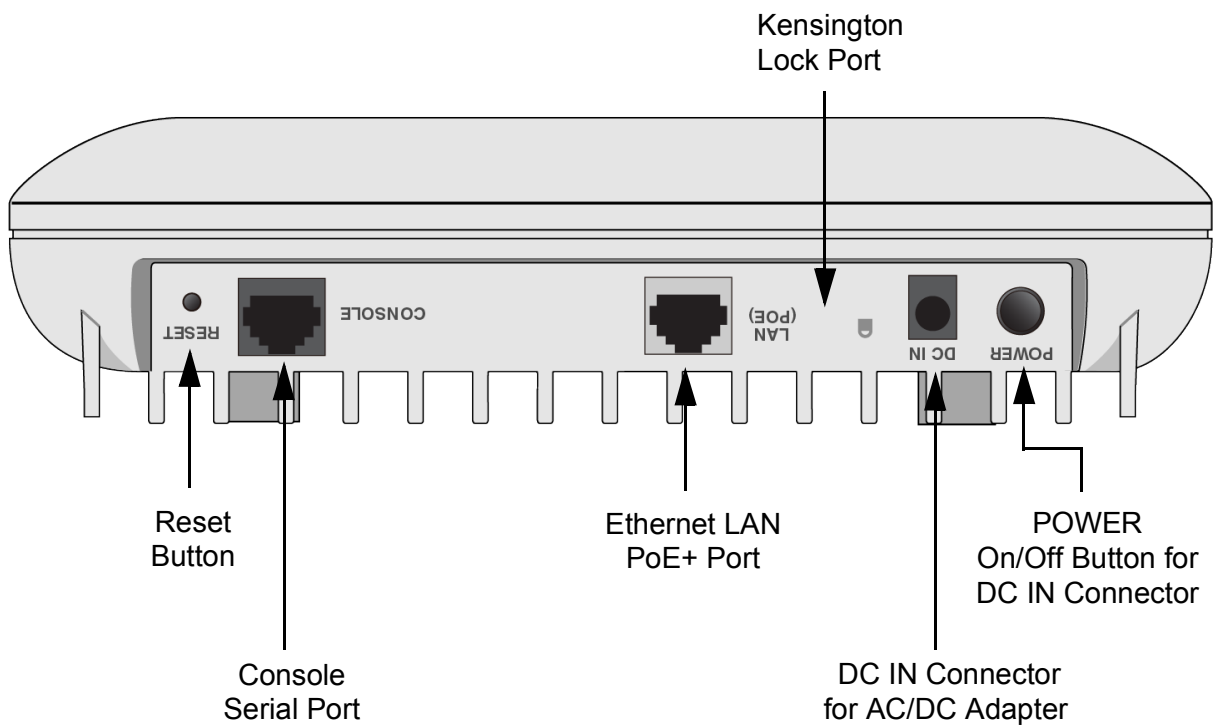

Figure 3. Rear Panel

Note

The Console Serial port is for manufacturing purposes only.

Ethernet LAN Port

The wireless access point has one Ethernet LAN port on the rear panel, with these operational properties:

- ❑ 10Mbps (IEEE 802.3), 100Mbps (IEEE 802.3u), 1000Mbps (IEEE 802.3ab), 2.5Gbps, and 5Gbps (IEEE 802.3bz)
- ❑ Flow control (IEEE 802.3x)
- ❑ VLAN tagging (IEEE 802.1Q)
- ❑ Auto-Negotiation for speed and duplex mode
- ❑ Auto-MDI/MDIX at 10/100Mbps

The port has the following functions:

- ❑ You use it to connect the wireless access point to a device on your wired network, such as Ethernet switch or router. The port makes it possible for wireless clients of the wireless network to gain access to the wired network.
- ❑ The Ethernet LAN port can also be used to provide the electrical power to the device. The wireless access point is a PoE powered device, meaning it can be powered by a PoE power source on the port. A PoE power source can be a PoE router or switch, such as the x320-10GH Switch from Allied Telesis. Electrical power is transmitted to the wireless access point by the power source over the same network cable that carries the network traffic.

Power Over Ethernet

You can power the wireless access point as a PoE+ Class 4 device on the LAN port. Powering the device with PoE requires connecting the LAN port to a PoE source device.

You can also power the device with an external AC/DC adapter, such as the PWRADP-01 (DA-48Z12) Power Adapter. Refer to “How to Power the Wireless Access Point” on page 28.

Connector Type

The LAN port has an eight-pin RJ45 connector. The port uses four pins in the connector at 10/100 Mbps and all eight pins at higher speeds. Refer to the tables in “Port Pinouts” on page 72 for the pin assignments.

Speed

The LAN port can operate at 10/100Mbps/1/2.5/5Gbps. The speed is set automatically with Auto-Negotiation. You cannot disable Auto-Negotiation on the port.

Note

You should connect the LAN port to a network device that also supports Auto-Negotiation. The LAN port operates at 10Mbps if it is connected to a network device that does not support Auto-Negotiation. This may result in reduced network performance.

Duplex Mode

The LAN port can operate in either half- or full-duplex mode at 10/100Mbps, and full-duplex mode at higher speeds. The port is IEEE 802.3u-compliant and uses Auto-Negotiation to set the duplex mode. You cannot disable Auto-Negotiation on the port.

Note

You should connect the LAN port to a network device that also supports Auto-Negotiation for duplex mode. If connected to a network device that does not support Auto-Negotiation, it operates at half-duplex mode. This will result in a duplex mode mismatch if the network device is operating at full duplex. This may result in reduced network performance.

**Automatic MDIX
Detection**

The LAN port is IEEE 802.3ab compliant. It features automatic MDIX detection when operating at 10/100Mbps. (Automatic MDIX detection does not apply to higher speeds.) This feature automatically configures the port to MDI or MDIX depending on the wiring configuration of the port on the network device where it is connected.

You cannot disable automatic MDIX detection. For automatic MDIX detection to work properly, this feature must also be present on the network device. The LAN port defaults to MDIX if it is connected to a network device that does not support automatic MDIX detection.

Cable Requirements

The minimum cable requirements for the port are listed here.

- ❑ 10/100 Mbps: Standard TIA/EIA 568-B-compliant Category 3 shielded or unshielded cabling.
- ❑ 1/2.5/5Gbps: Standard TIA/EIA 568-A-compliant Category 5 or TIA/EIA 568-B-compliant Enhanced Category 5 (Cat 5e) shielded or unshielded cabling.

Maximum Distance

The LAN port has a maximum operating distance of 100 meters (328 feet).

Port Pinouts

Refer to Table 8 on page 72 for the port pinouts of the LAN port when it is operating at 10/100Mbps in the MDI configuration and Table 9 on page 73 for the MDI-X configuration. Refer to Table 10 on page 73 for the port pinouts when the port is operating at 1/2.5/5Gbps.

How to Power the Wireless Access Point

There are three ways to power the wireless access point:

- ❑ “External AC/DC Power Adapter,” next
- ❑ “PoE+ Power Source” on page 28
- ❑ “Both AC/DC Power Adapter and PoE Power Source” on page 29

Note

The input power specifications of the wireless access point are listed in Table 4 on page 70 in Appendix A, “Technical Specifications” on page 69.

External AC/DC Power Adapter

One way to power the wireless access point is with an external AC/DC power adapter, such as the PWRADP-01 (DA-48Z12) Power Adapter from Allied Telesis. Refer to Figure 4. The power adapter is connected to the DC IN connector on the rear panel of the wireless access point.

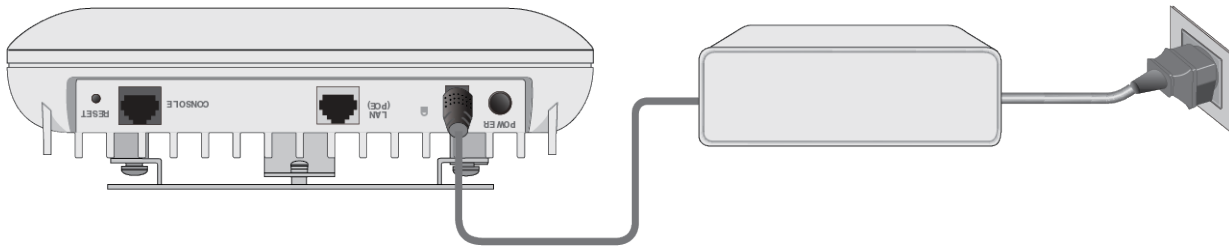

Figure 4. Powering the Access Point with an AC/DC Power Adapter

PoE+ Power Source

The wireless access point is a PoE+ powered device, Class 4. It can be powered by a PoE power source on its Ethernet LAN port. An example of a PoE power source is the x320-10GH PoE++ Ethernet Switch from Allied Telesis. Refer to Figure 5.

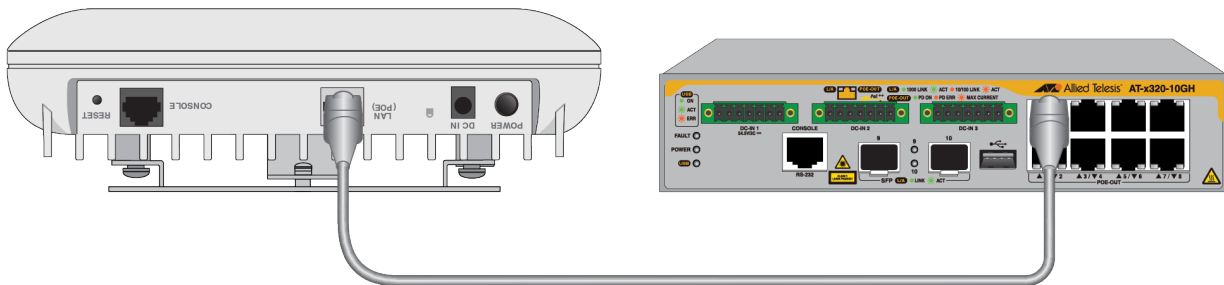

Figure 5. Powering the Access Point with a PoE Power Source

Both AC/DC Power Adapter and PoE Power Source

Finally, the device can be powered by both an external AC/DC power adapter and a PoE+ power source. Refer to Figure 6.

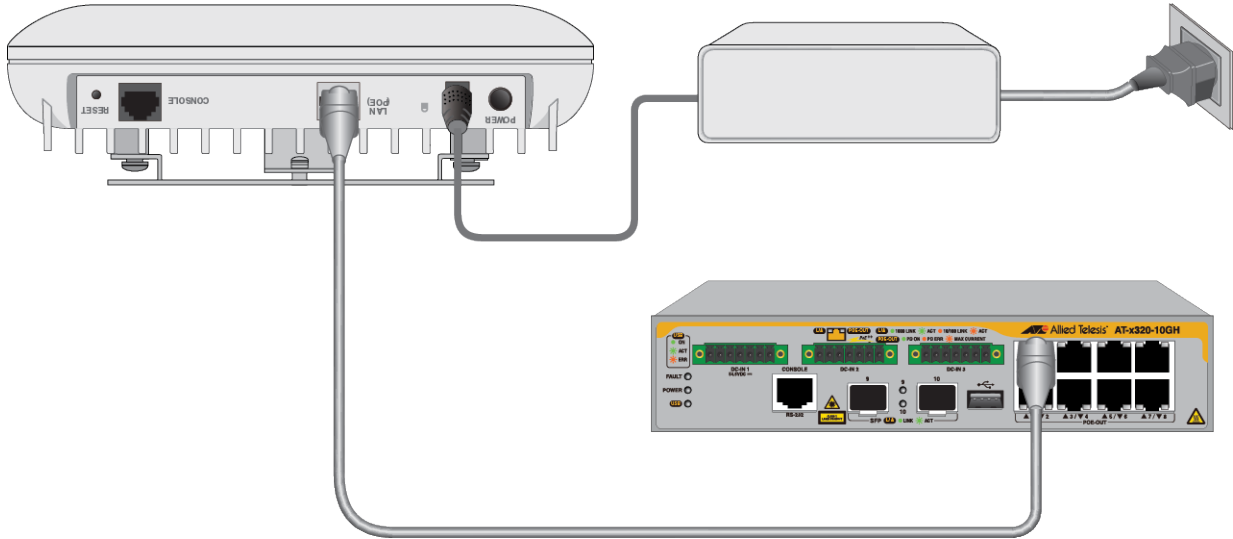

Figure 6. Powering the Access Point with Both an External AC/DC Adapter and a PoE+ Power Source

Here are the operating rules of the wireless access point when connected to both an AC/DC power adapter and a PoE+ power source:

- ❑ The two power sources are not load sharing. The power adapter is the primary power source and PoE is held in reserve. The LAN port operates as a standard Ethernet LAN port, with PoE blocked.
- ❑ If the power adapter stops providing power, the wireless access point automatically changes to PoE on the LAN port as its power source.
- ❑ If the power adapter resumes providing power, the wireless access point automatically switches back to the power adapter as its primary power source. PoE on the LAN port is blocked and returned to reserve status.

DC Connector for an External AC/DC Power Adapter

The DC IN connector is for an external AC/DC power adapter, such as the PWRADP-01 Power Adapter from Allied Telesis, shown in Figure 7.

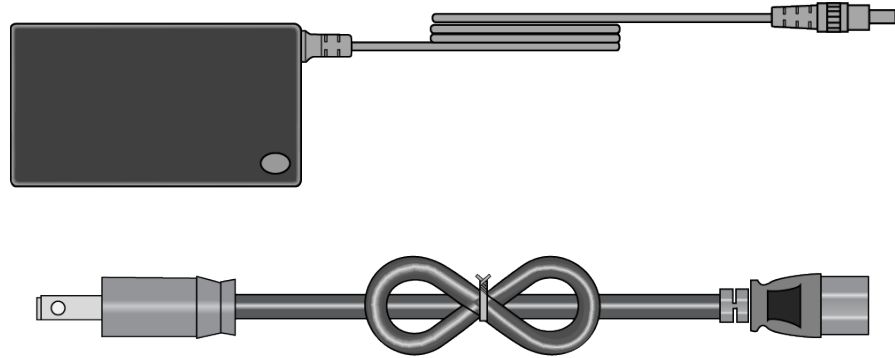

Figure 7. PWRADP-01 Power Adapter

You can power the wireless access point with either an external power adapter on the DC IN connector or a PoE+ power source on the Ethernet LAN port. You can also power it with both power sources. Refer to “How to Power the Wireless Access Point” on page 28 and “Power Specifications” on page 70.

Note

Use only power sources that are UL Listed (QQGQ or EPBU), TUV Licensed, or other Safety Agencies approved, and that are suitable for country of use.

POWER On/Off Button

The POWER On/Off button on the rear panel powers on or off the DC IN connector for an external AC/DC power adapter. Here are the button settings:

- ❑ In - The DC IN connector is On, allowing power from the AC/DC adapter.
- ❑ Out - The DC IN connector is Off, blocking power from the AC/DC adapter.

Here are the guidelines:

- ❑ If the wireless access point is powered by both an AC/DC power adapter and a PoE power source, turning off the DC IN connector shuts off power from the adapter. The access point automatically switches over to PoE for power.
- ❑ If the wireless access point is powered only by an AC/DC power adapter, turning off the DC IN connector shuts down the device.

LEDs

The LEDs on the top panel display status information. They are defined in Table 1.

Table 1. LED Status Information

LED	State	Description
Power	Solid Green	The access point is powered on and operating normally.
	Solid Red	The device is booting up or has encountered a fault condition.
	Blinking Red	The access point is upgrading its firmware.
	Off	The access point is not receiving power.
LAN	Solid Green	The port has established a link to a network device.
	Blinking Green	The port is transmitting or receiving data.
	Solid Amber	The LAN port is connected to a PoE+ source device.
	Off	The port has not established a link to a network device.
2.4GHz Wi-Fi	Solid Green	The 2.4GHz Radio1 is enabled.
	Slow Blinking Green	The access point is querying the wireless network on the 2.4GHz radio for a Smart Connect network of Vista Manager EX and the AWC plug-in.
	Fast Blinking Green	The access point is in a Smart Connect network and will automatically configure its settings from the AWC plug-in.
	Off	The 2.4GHz Radio1 is disabled.

Table 1. LED Status Information

LED	State	Description
5GHz Wi-Fi	Solid Green	The 5GHz Radio2 is enabled.
	Slow Blinking Green	The access point is querying the wireless network on the 5GHz radio for a Smart Connect network of Vista Manager EX and the AWC plug-in.
	Fast Blinking Green	The access point is a member of a Smart Connect network and will automatically configure its settings from the AWC plug-in.
	Off	The 5GHz Radio2 is disabled.

Reset Button

The wireless access point has a Reset button on the rear panel for returning the parameter settings of the device to their default values. You might reset the access point if you want to discard its current configuration or if you forgot the manager password and so cannot manage the device.

To reset the device, press the button for five seconds and release.

You can enable or disable the reset button with the management software. The default setting for the button is enabled. If the access point is installed in a public area, you probably should disable it to protect the device from being reset by unauthorized individuals.

Management Tools

The wireless access point supports the following management tools.

Web Browser

The wireless access point has a web browser management interface for configuring the device from your management workstation. The web browser interface allows you to manage one unit at a time and supports both non-secure HTTP and secure HTTPS management sessions. The default is HTTP. The product has been tested with Microsoft Internet Explorer version 11 or later, Microsoft Edge, and Chrome.

Vista Manager EX and AWC Plug-in

The wireless access point supports Vista Manager and the Autonomous Wave Control (AWC) plug-in. Configuring and monitoring large numbers of devices is simplified with AWC because you can add multiple devices to management groups and manage them as one unit. The application can also monitor the operations of the wireless access points and automatically adjust operating properties to optimize the performance of your wireless network.

Note

The Channel Blanket feature in the TQ6602 Access Point requires Vista Manager EX and the AWC plug-in.

Note

The TQ6602 Wireless Access Point requires Vista Manager EX and AWC plug-in version 2.5.1 or later.

SNMP

You can use SNMPv1 or v2c to view the parameter settings of the devices. The MIB is available from the Allied Telesis web site. For instructions on how to configure the unit for SNMP, refer to the *TQ6602 Wireless Access Point Management Software User Guide*.

Chapter 2

Beginning the Installation

This chapter contains the following sections:

- “Reviewing Safety Precautions” on page 38
- “Choosing a Site for the Wireless Access Point” on page 41
- “Unpacking the Shipping Box” on page 42

Note

The non-US models of this product have a country code setting that has to be set during the initial management session of the units. The setting ensures that the units operate in compliance with the laws and regulations of your country or region.

For the US model, the country code is preset and cannot be changed. Per FCC regulations, the country code setting for all WiFi products marketed in the US have to be fixed to US operational channels only.

Reviewing Safety Precautions

Please review the following safety precautions before installing the access point.

Important: Safety statements that have the  symbol are translated into multiple languages in the *Translated Safety Statements* document, which is available at www.alliedtelesis.com/library.

Remarque: Les consignes de sécurité portant le symbole  sont traduites dans plusieurs langues dans le document *Translated Safety Statements*, disponible à l'adresse www.alliedtelesis.com/library.



Warning

To prevent electric shock, do not remove the cover. No user-serviceable parts inside. This unit contains hazardous voltages and should only be opened by a trained and qualified technician. To avoid the possibility of electric shock, disconnect electric power to the product before connecting or disconnecting the LAN cables.

 E1



Warning

Do not work on equipment or cables during periods of lightning activity.  E2



Warning

All Countries: Install product in accordance with local and National Electrical Codes.  E8



Warning

Only trained and qualified personnel are allowed to install or to replace this equipment.  E14



Warning

To reduce the risk of electric shock, the PoE ports on this product must not connect to cabling that is routed outside the building where this device is located.  E40

**Warning**

This equipment shall be installed in a Restricted Access location.
E45

**Warning**

FCC Caution: Any changes or modifications not expressly approved by the party responsible for compliance could void the user's authority to operate this equipment. E80

Note

The access point must be powered by:

1. A UL listed external AC/DC power supply suitable for use at Tma 50°C, a maximum operating altitude of 3000 m or higher, and whose output meets separated extra-low voltage (SELV), limited power sources (LPSs) and is rated 12 VDC, 4.0 A, Refer to Table 5, "External AC/DC Power Adapter Specifications" on page 70.

OR

2. By Power over Ethernet through a UL listed ITE.

**Caution**

Air vents must not be blocked and must have free access to the room ambient air for cooling. E6

**Warning**

An operational unit can be hot. Exercise caution when handling with unprotected hands. E125

**Warning**

Hot Surface! The finned surface on the back of the chassis is a heat sink that can become dangerously hot exceeding 70°C (158° F) E114.

**Warning**

Operating Temperature. This product is designed for a maximum ambient temperature of 50°C (122° F) E7.



Warning

To reduce the risk of electric shock, the PoE port on this product must not connect to cabling that is routed outside the building where this device is located. ⚡ E40



Warning

This equipment is intended for indoor use only. ⚡ E95

Note

If you are not using PoE to power to unit, use only an approved AC/DC adapter. Refer to “External AC/DC Power Adapter Specifications” on page 70.



Caution

The unit does not contain serviceable components. Please return damaged units for servicing. ⚡ E42

Note

You should verify that your PoE network adheres to the standards of a separated extra-low voltage (SELV) circuit before using the PoE feature on the wireless access point.

Choosing a Site for the Wireless Access Point

Observe these requirements when planning the installation of the wireless access point:

- ❑ The ceiling or wall mounting surface should be of proper material to accommodate the screws and strong enough to support the weight of the wireless access point and cables. (Refer to Table 2 on page 69 for product weight.)
- ❑ Verify that the Ethernet cable is long enough to connect to its destination port.
- ❑ If the wireless access point will be powered by an AC/DC adapter, verify that an AC power outlet is within six feet of the planned installation site.
- ❑ The site should allow for easy access to the Ethernet port on the device, so that you can easily connect and disconnect the cable.
- ❑ The site should allow for adequate air flow around the unit and through the cooling vents on the bottom panel.
- ❑ The site should not expose the device to moisture or water.
- ❑ The site should be a dust-free environment.
- ❑ The site should not expose the twisted pair cabling to sources of electrical noise, such as radio transmitters, broadband amplifiers, power lines, electric motors, and fluorescent fixtures.
- ❑ Do not place objects on top of the device.
- ❑ If installing the device in a wiring or utility box, verify that there is adequate airflow to prevent overheating.

Unpacking the Shipping Box

The contents of the shipping box are shown in Figure 8. Verify and inspect the contents. If any item is missing or damaged, contact your Allied Telesis sales representative for assistance.

Note

Store the packaging material in a safe location. Please use the original shipping material if you need to return the device to Allied Telesis.

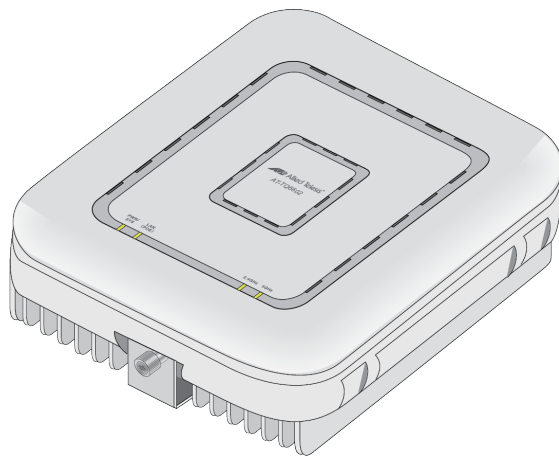

TQ6602 Wireless Access Point

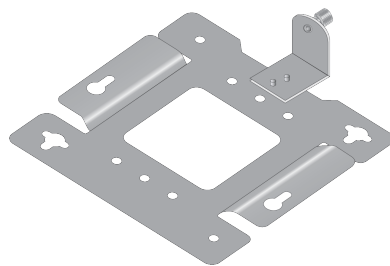

Wall Mounting Bracket

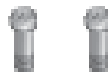

Two M5 x 8mm,
Pan-head Screws

Figure 8. Shipping Box Contents

Chapter 3

Installing the Wireless Access Point

This chapter contains the installation procedures for the TQ6602 Wireless Access Point. The procedures are detailed in the following sections:

- ❑ “Installing the Wireless Access Point on a Table” on page 44
- ❑ “Overview to Installing the Wireless Access Point on a Wall or Ceiling” on page 48
- ❑ “Installing the Mounting Bracket on a Wall or Ceiling” on page 51
- ❑ “Installing the Mounting Bracket Screws” on page 55
- ❑ “Connecting an Ethernet Cable to the Ethernet LAN Port” on page 56
- ❑ “Connecting the AC/DC Power Adapter” on page 57
- ❑ “Attaching the Wireless Access Point to the Wall Mounting Bracket” on page 59
- ❑ “Installing an Anti-theft Device” on page 61

Installing the Wireless Access Point on a Table

Figure 9 Shows the wireless access point on a table.

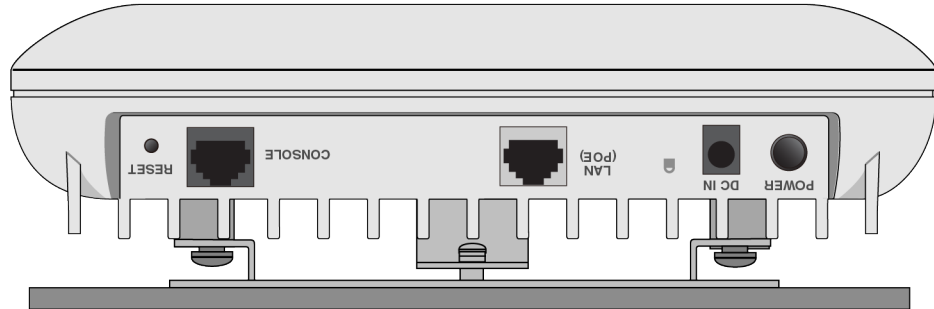

Figure 9. TQ6602 Wireless Access Point on a Table

You need the following items to install the access point on a table:

- TQ6602 Wireless Access Point.
- Wall mounting bracket (provided).
- Two screws to attach the wall mounting bracket to the access point (provided).
- One Ethernet cable.
- External AC/DC power supply (Optional if using PoE. Required if not using PoE or for redundant power).
- Kensington lock (optional).

Note

Allied Telesis recommends installing the wall mounting bracket on the bottom panel of the wireless access point when installing the device on a table. The bracket will facilitate airflow through the cooling fins under the device.

Note

Please see “Reviewing Safety Precautions” on page 38 and “Choosing a Site for the Wireless Access Point” on page 41 before installing the product.

Perform the following steps to install the wireless access point on a table:

1. Place the wireless access point upside down on a table.
2. Install the two screws (provided) fully into the bottom panel of the access point. Refer to Figure 10 on page 45.

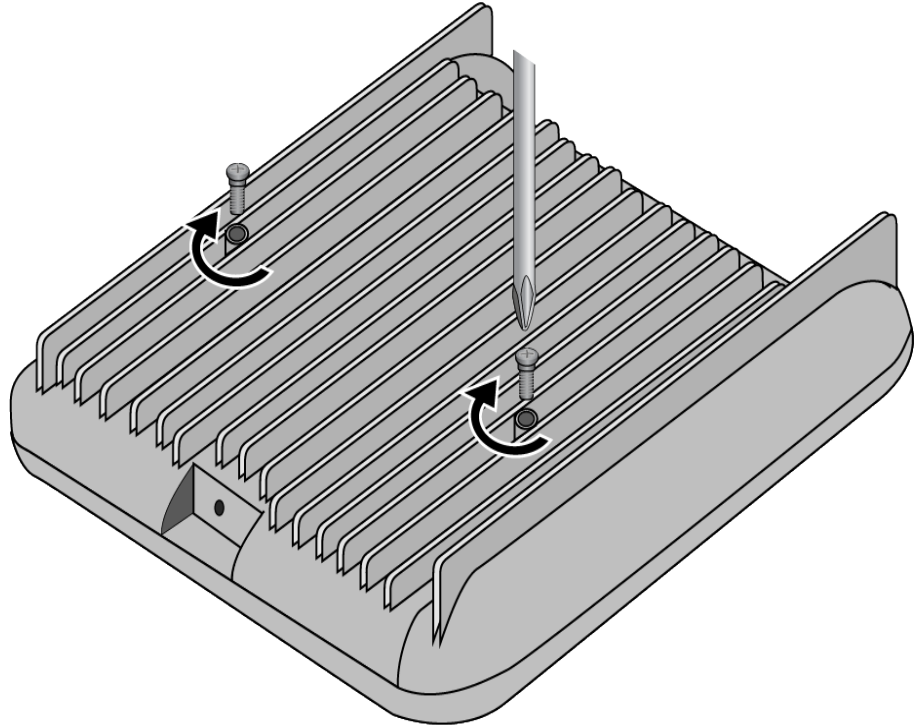

Figure 10. Installing the Bracket Screws

The screw collar provides the proper spacing for the mounting bracket beneath the screw head. Refer to Figure 11.



Figure 11. Panel Screws

3. Slide the mounting bracket beneath the screws. Refer to Figure 12 on page 46.

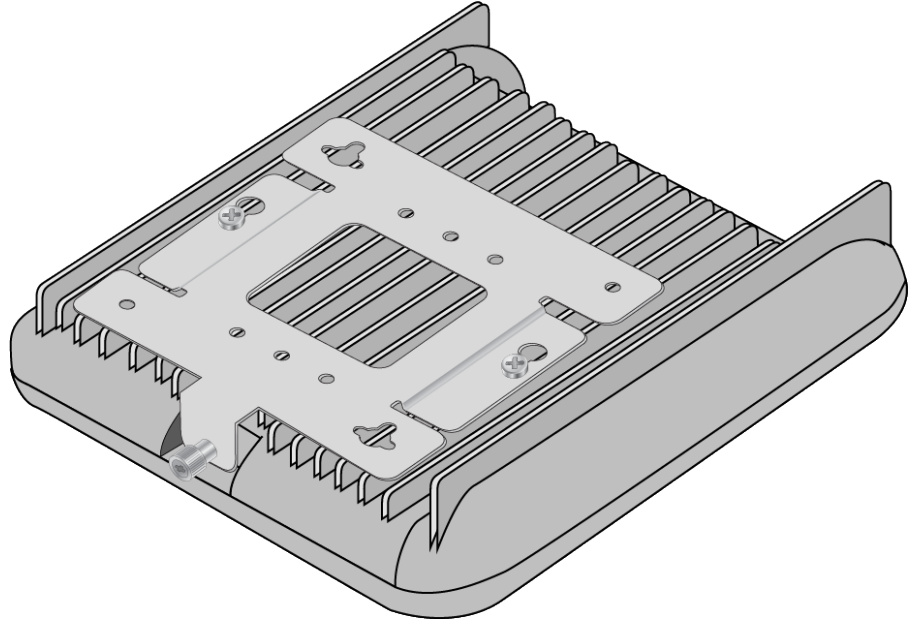

Figure 12. Installing the Mounting Bracket

4. Tighten the bracket retaining screw. Refer to Figure 13.

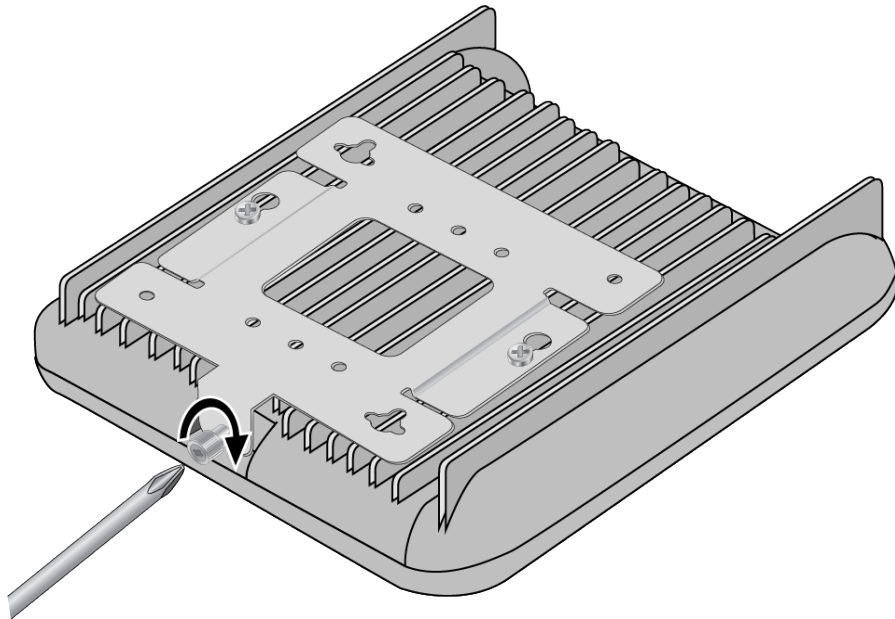

Figure 13. Tightening Bracket Retaining Screw

5. Turn the wireless access point upright on the table.
6. Place the wireless access point at the selected location.

7. Go to one the following procedures
 - ❑ “Connecting an Ethernet Cable to the Ethernet LAN Port” on page 56.
 - ❑ “Connecting the AC/DC Power Adapter” on page 57.
 - ❑ “Installing an Anti-theft Device” on page 61.

Overview to Installing the Wireless Access Point on a Wall or Ceiling

You can install the wireless access point on a wall with the front panel pointing to the left, down, or right. Refer to Figure 14.

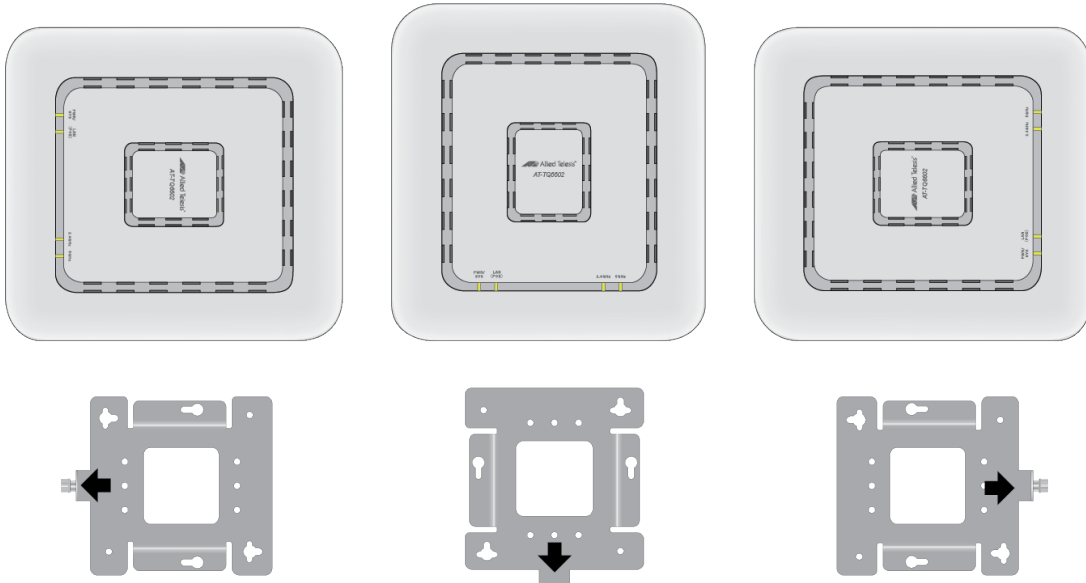

Figure 14. Orientations of the TQ6602 Wireless Access Point on a Wall

Do not install the device with the front panel facing up. Refer to Figure 15.

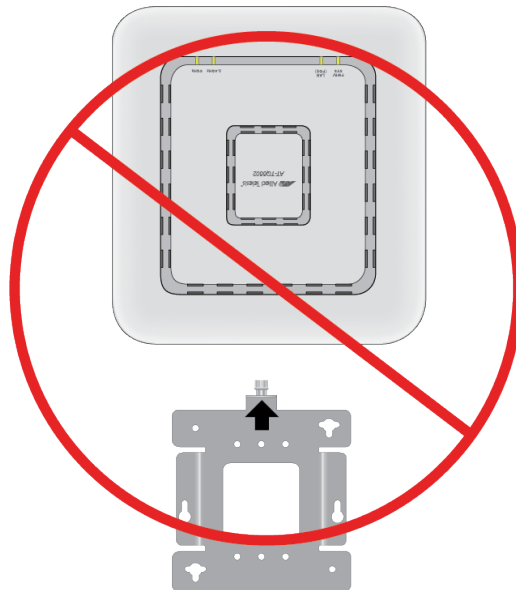

Figure 15. Invalid Position of the TQ6602 Wireless Access Point on a Wall

Figure 16 shows the device installed on a ceiling.

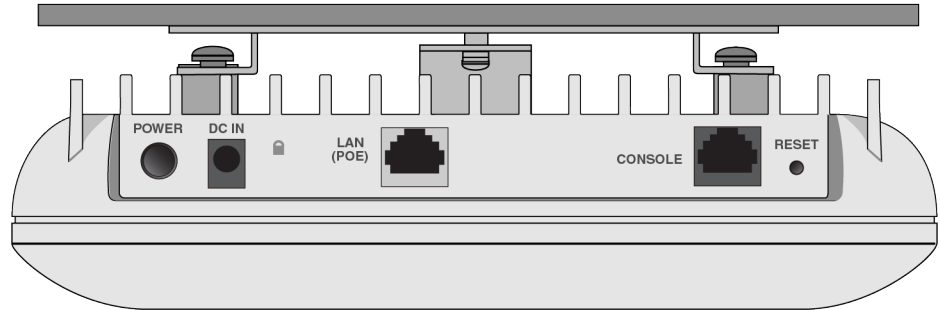

Figure 16. TQ6602 Wireless Access Point on the Ceiling

Here are the procedures for installing the wireless access point on a wall or ceiling:

- “Installing the Mounting Bracket on a Wall or Ceiling” on page 51
- “Installing the Mounting Bracket Screws” on page 55
- “Connecting an Ethernet Cable to the Ethernet LAN Port” on page 56
- “Connecting the AC/DC Power Adapter” on page 57
- “Attaching the Wireless Access Point to the Wall Mounting Bracket” on page 59
- “Installing an Anti-theft Device” on page 61

Note

Please see “Reviewing Safety Precautions” on page 38 and “Choosing a Site for the Wireless Access Point” on page 41 before installing the product.

Depending on the installation location, it may be easier to connect the network cables and power adapter to the wireless access point before installing it on the wall or ceiling.

You need the following items to install the wireless access point on a ceiling or wall:

- TQ6602 Wireless Access Point
- Two screws to attach the access point to the mounting bracket (provided)
- Wall mounting bracket (provided)
- Four (4) M4, 25.0 mm flat-head wood screws and anchors for fastening the mounting bracket (not provided)
- Phillips head screwdriver (not provided)
- Pencil (not provided)

- ❑ External AC/DC power supply (Optional if using PoE. Required if not using PoE or for redundant power.)
- ❑ Kensington lock (optional and not provided)

Note

The four Phillips head M4 screws/anchors, the Phillips head screwdriver, pencil, external AC/DC power supply and Kensington lock are not included with the product.

Installing the Mounting Bracket on a Wall or Ceiling

To install the mounting bracket on a wall or ceiling, perform the following procedure:

1. Choose the location and orientation for the access point on the wall or ceiling. Refer to Figure 14 on page 48.
2. Position the mounting bracket at the selected location and orientation for the access point. Consider the following guidelines.
 - ❑ The thumbscrew on the mounting bracket is where the front panel of the access point will be.
 - ❑ The ports and connectors are on the back panel, away from the thumbscrew.
3. With a pencil, mark the wall or ceiling with the two key-hole slots of the bracket. Refer to Figure 17.

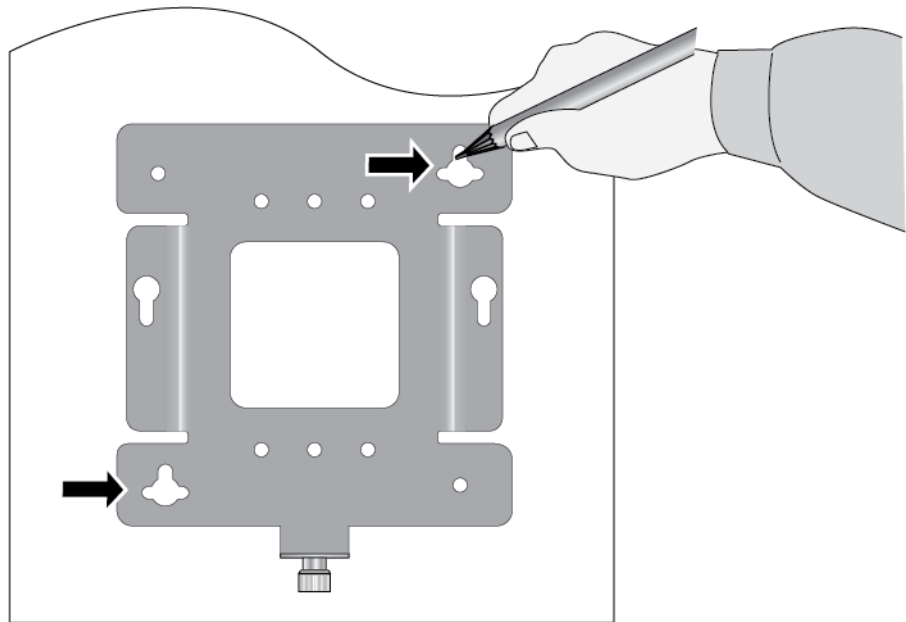

Figure 17. Marking the Holes for the Key-Hole Slots

4. Pre-drill the two marked locations for the keyhole slots on the ceiling or wall.
5. Install two M4 screws and anchors (if required). Leave the screws loose enough so that the bracket can slide under the screw heads. Refer to Figure 18 on page 52.

Note

For a wooden wall or ceiling, use M4, 25.0 mm flat-head wood screws and anchors, if required. The screws and anchors are not provided with the wireless access point.

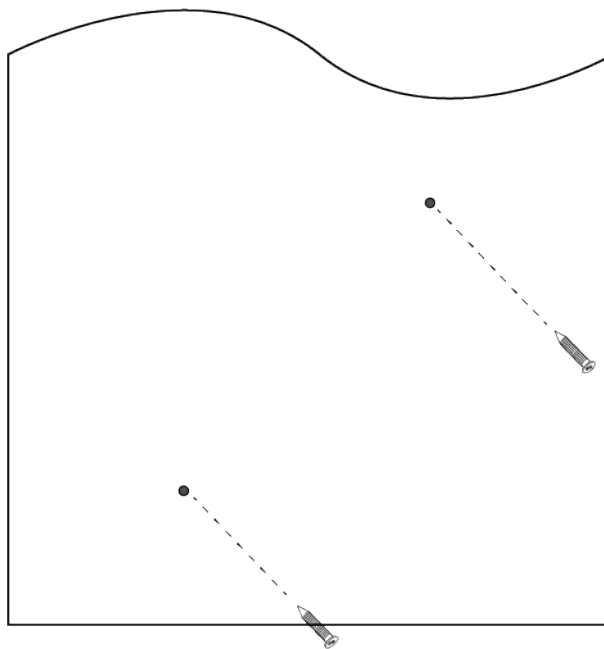

Figure 18. Installing Two Screws

6. Insert the openings of the bracket key-hole slots under the two screw heads and slide the bracket into the narrow end of the key-hole slot openings. Refer to Figure 19 on page 53.

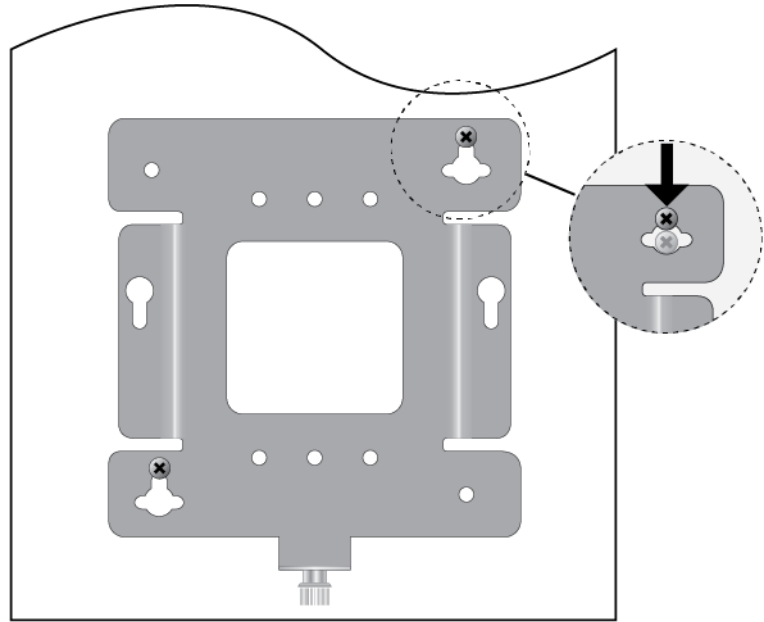

Figure 19. Installing the Wall Mounting Bracket On the Screws

7. Tighten the screws snugly onto the bracket.
8. To secure the mounting bracket, pre-drill holes through the two bracket mounting holes opposite the key-hole slots. Refer to Figure 20.

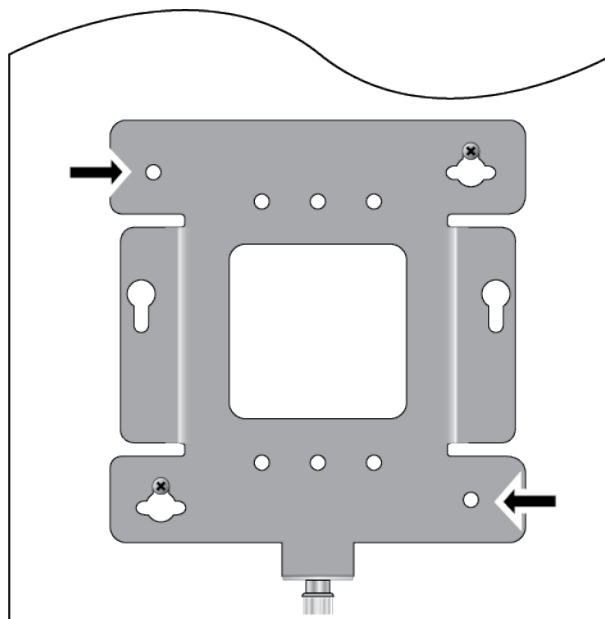

Figure 20. Pre-Drill Holes on Wall Mounting Bracket

9. Install and tighten two M4 screws (not provided) in the holes prepared in Step 8. Refer to Figure 21. The bracket installation is now complete.

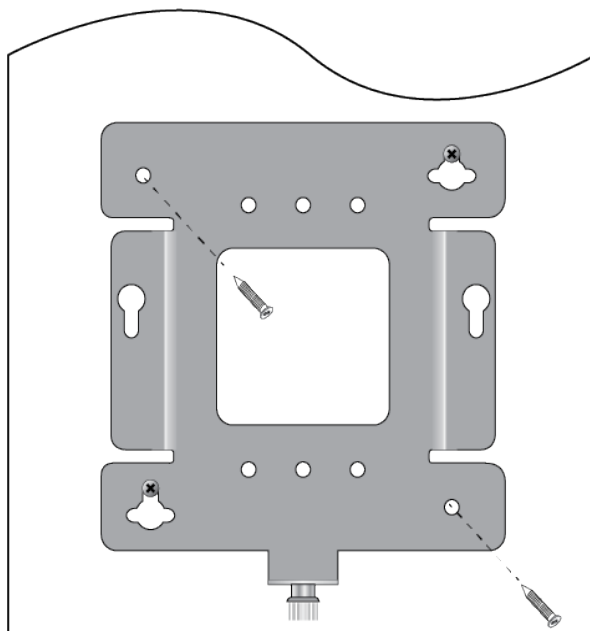

Figure 21. Securing the Wall Mounting Bracket

10. Go to “Installing the Mounting Bracket Screws” on page 55.

Installing the Mounting Bracket Screws

To install the mounting bracket screws in the wireless access point, perform the following procedure:

1. Place the wireless access point upside down on a table.
2. Install the two screws (provided) fully into the bottom panel of the access point. Refer to Figure 22.

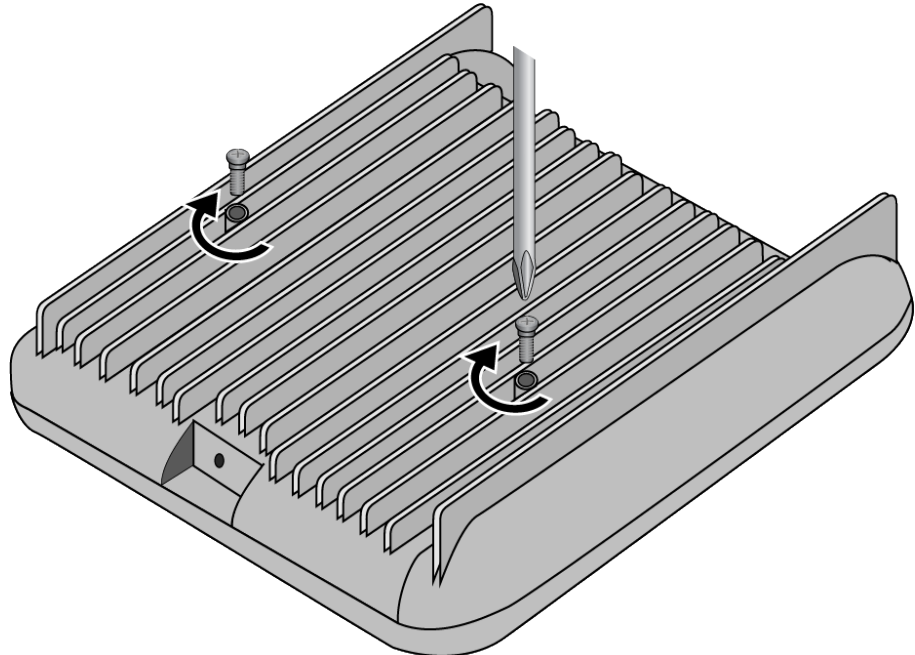

Figure 22. Installing the Bracket Screws into the Wireless Access Point

The screw collar provides the proper spacing for the mounting bracket beneath the screw head. Refer to Figure 11 on page 45.

3. Do one of the following:
 - Depending on the installation location, it may be easier to connect the Ethernet cable and optional AC/DC power adapter to the wireless access point before installing it on the wall of ceiling. If that is the case in your installation, continue with the installation by going to “Connecting an Ethernet Cable to the Ethernet LAN Port” on page 56.
 - To install the wireless access point on the wall of ceiling before attaching the cables, go to “Attaching the Wireless Access Point to the Wall Mounting Bracket” on page 59.

Connecting an Ethernet Cable to the Ethernet LAN Port

This section contains the procedure for connecting an Ethernet cable to the LAN port. For information on cable specifications, refer to “Cable Requirements” on page 27. Please review the following guidelines before connecting the Ethernet cable:

- ❑ If you are installing the wireless access point on a ceiling or wall, you might find it easier to connect the cable before placing the unit on the wall mounting bracket.
- ❑ To power the wireless access point with PoE, connect the LAN port to a PoE source device. For power specifications, refer to “PoE+ Power Requirements” on page 70.

To connect the network cable, perform the following procedure:

1. Connect an Ethernet cable into the RJ-45 LAN port. Refer to Figure 23.

Note

If the other end of the Ethernet cable is already connected to a PoE source device, the wireless access point begins to power on and initialize its management software.

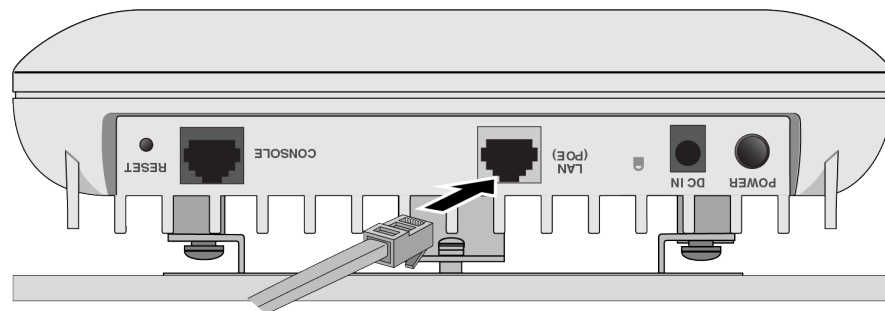

Figure 23. Connecting an Ethernet Cable to the LAN Port

2. Connect the other end of the Ethernet cable to a network Ethernet device, such as an Ethernet switch or router.
3. Do one of the following:
 - ❑ If the access point will be powered by PoE only, without an AC/DC power adapter, go to “Attaching the Wireless Access Point to the Wall Mounting Bracket” on page 59.
 - ❑ To power the access point with an external AC/DC power adapter, go to “Connecting the AC/DC Power Adapter” on page 57.

Connecting the AC/DC Power Adapter

You can power the wireless access point with PoE on the LAN port or an AC/DC power adapter, or both. Refer to “How to Power the Wireless Access Point” on page 28. To connect a power adapter to the wireless access point, perform the following procedure:

1. If you purchased the PWRADP-01 Power Adapter, connect the AC power cord to the power adapter. Refer to Figure 24.

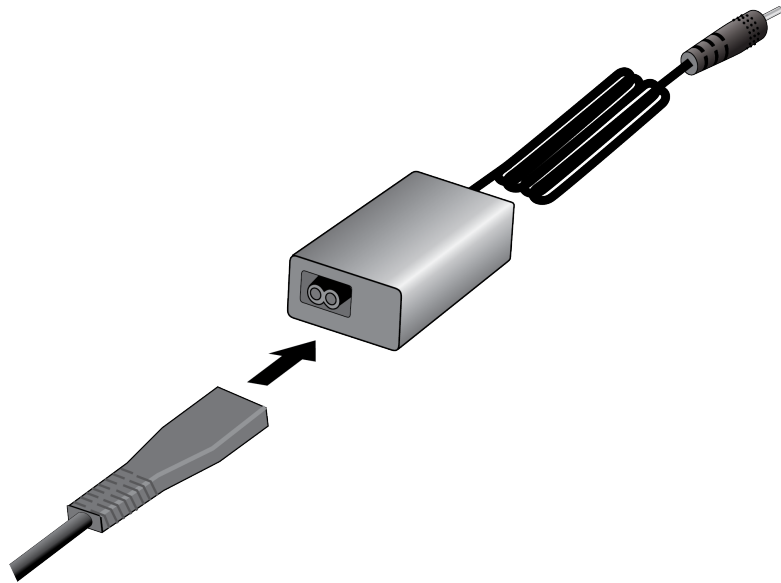

Figure 24. Connecting the AC Power Cord to the PWRADP-01 Power Adapter

2. Plug the DC cable from the power adapter into the DC IN connector on the wireless access point. Refer to Figure 25.

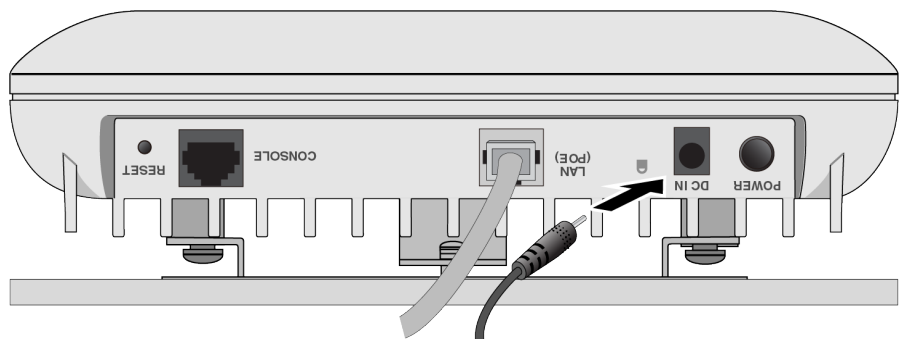

Figure 25. Connecting an AC/DC Power Adapter to the DC IN Connector

3. Connect the power adapter into an appropriate AC power source. Refer to Figure 26.

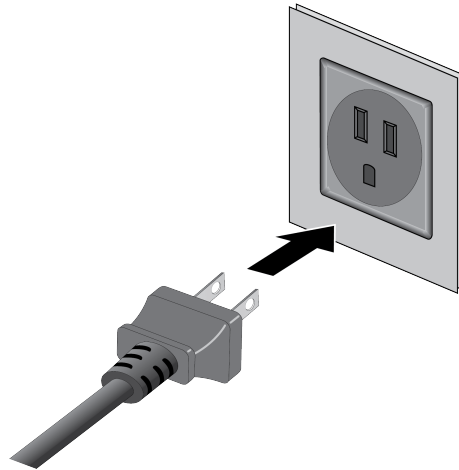

Figure 26. Connecting the Power Cord on the PWRADP-01 Power Adapter to an AC Source

4. Push the DC Power On/Off Button on the wireless access point to the “IN” position to turn on the DC connector. Refer to Figure 27.

Note

The DC Power Button controls the DC connector. It does not control PoE on the LAN port.

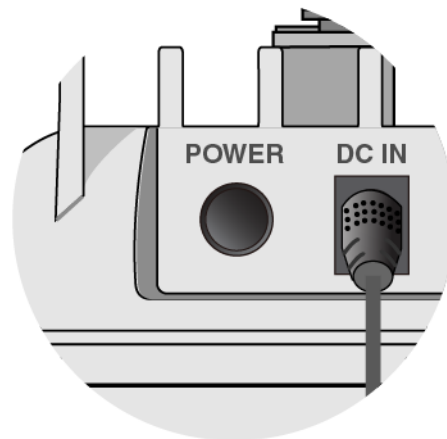

Figure 27. DC Power On/Off Button

The wireless access point begins to initialize its management software. The process takes about one minute to complete.

5. Go to “Attaching the Wireless Access Point to the Wall Mounting Bracket” on page 59.

Attaching the Wireless Access Point to the Wall Mounting Bracket

To attach the wireless access point to the wall mounting bracket on the wall or ceiling, perform the following procedure:

1. Align the bottom of the access point over the bracket so that the two screws on the bottom of the device fit into the bracket keyholes. Refer to Figure 28. (The two screws are installed in “Installing the Mounting Bracket Screws” on page 55.)

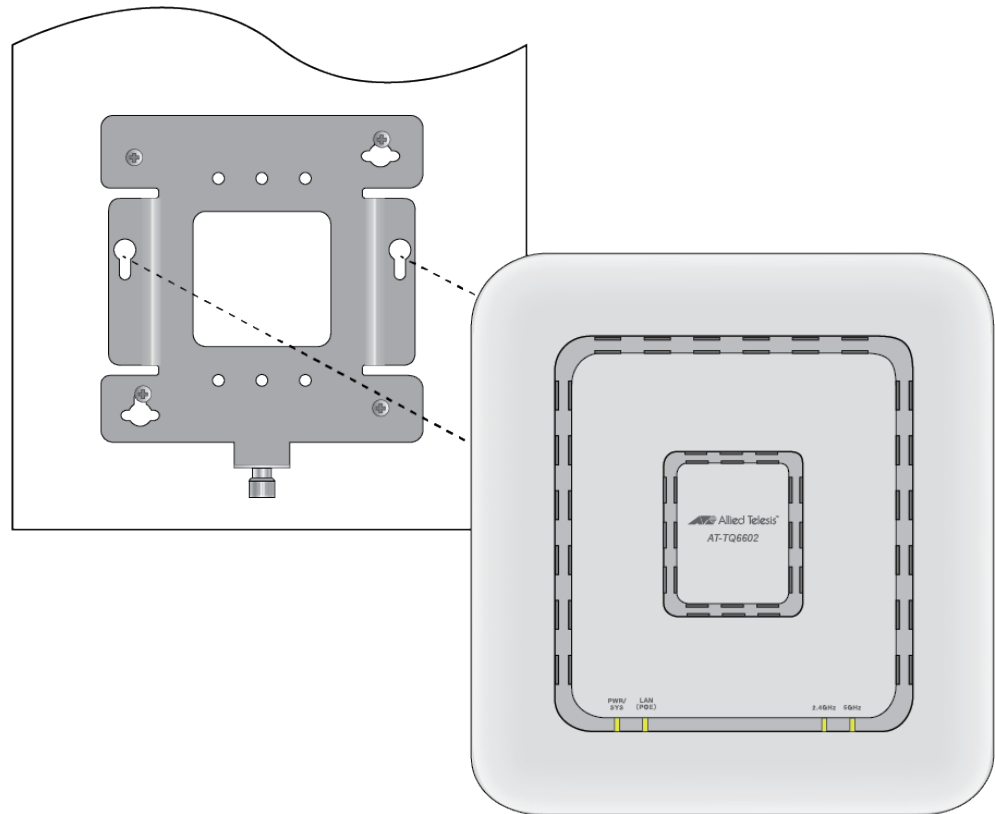

Figure 28. Installing the Wireless Access Point on the Wall Mounting Bracket

2. Slide the wireless access point until its screws are seated in the bracket keyhole slots and the bracket thumbscrew is aligned with the screw hole on the front panel. Refer to Figure 29 on page 60.

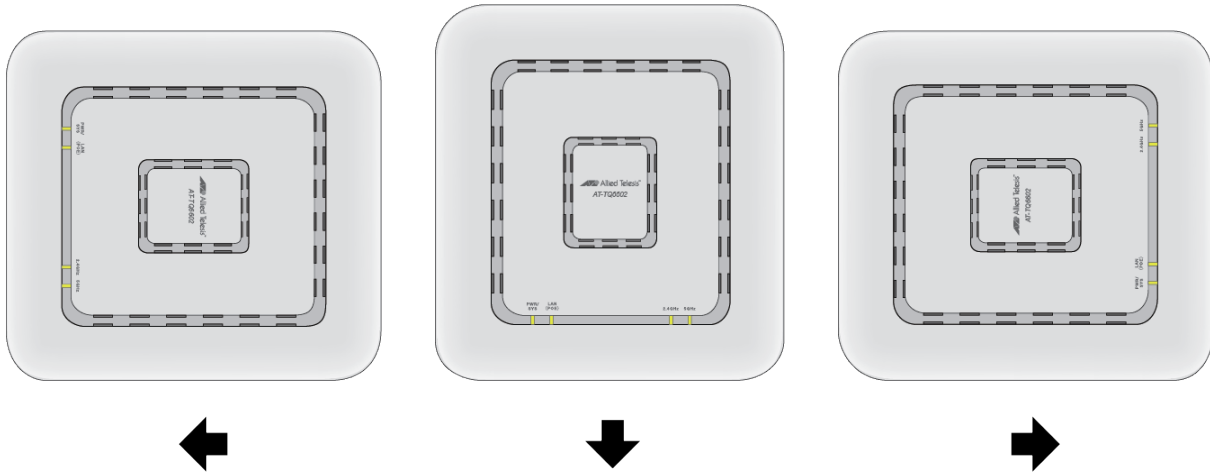

Figure 29. Seating the Wireless Access Point on the Wall Mounting Bracket

3. Tighten the thumbscrew to secure the wireless access point to the wall mounting bracket. Refer to Figure 30.

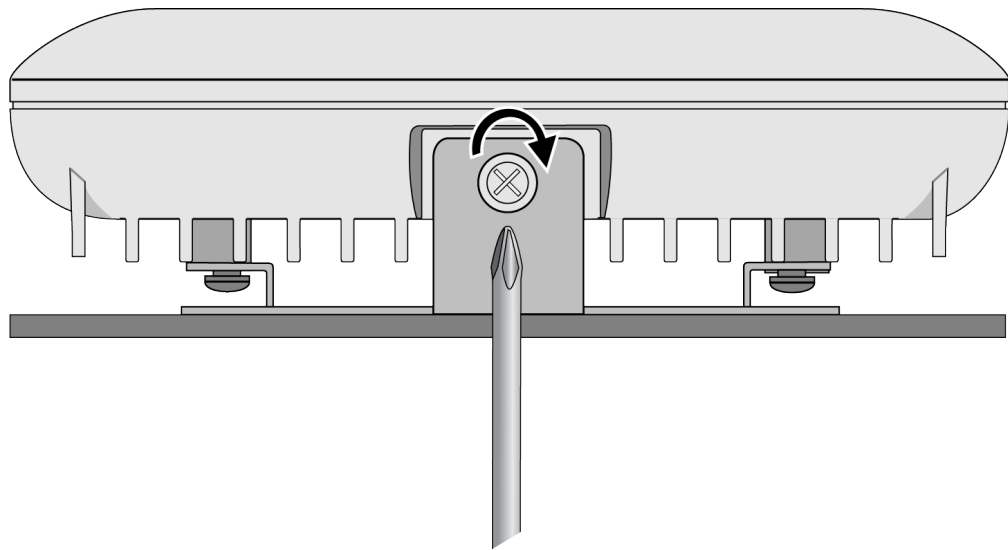

Figure 30. Tightening the Wall Mounting Bracket Thumbscrew

4. Go to “Installing an Anti-theft Device” on page 61 or Chapter 4, “Managing the Wireless Access Point” on page 63.

Installing an Anti-theft Device

Installation of an anti-theft cable/lock is optional. The access point has a lock port that is compatible with a Kensington lock. The lock port can be used to physically secure the device to a table, wall, or a ceiling.

Note

Anti-theft devices are not available from Allied Telesis.

Follow the instructions provided with the vendor's anti-theft device for the installation. Refer to Figure 31 for the Kensington lock port location.

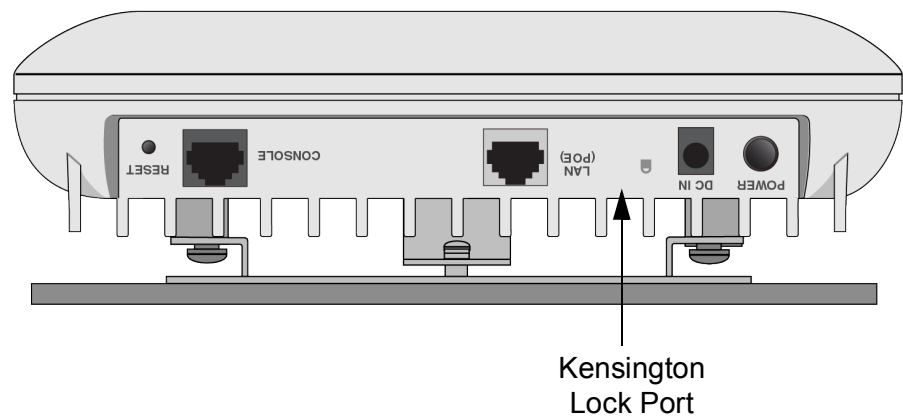

Figure 31. Kensington Lock Port

If you are installing the wireless access point on a wall or ceiling and have not installed it on the mounting bracket yet, go to “Attaching the Wireless Access Point to the Wall Mounting Bracket” on page 59. Otherwise, go to Chapter 4, “Managing the Wireless Access Point” on page 63.

Chapter 4

Managing the Wireless Access Point

This chapter contains the following sections:

- ❑ “Starting the First Management Session Without a DHCP Server” on page 64
- ❑ “Starting a Management Session” on page 67

Starting the First Management Session Without a DHCP Server

After you install and power on the wireless access point, it queries the subnet on the LAN port for a DHCP server. If a DHCP server responds to its query, the unit uses the IP address the server assigns to it. If there is no DHCP server, the access point uses the default IP address 192.168.1.230.

If your network has a DHCP server, use the IP address the server assigns it to to start the management session. For directions, refer to “Starting a Management Session” on page 67

If your network does not have a DHCP server, you can start the first management session by establishing a direct connection between your computer and the unit by connecting an Ethernet cable to the Ethernet port on the computer and the LAN1 port on the access point. This procedure requires changing the IP address on your computer to make it a member of the same subnet as the default IP address on the access point.

The first management session can also be performed while the device is connected to your network. However, if your network does not have a DHCP server, you still have to change the IP address of your computer to match the subnet of the default address of the access point. Furthermore, if your network is divided into virtual LANs (VLANs), you have to be sure to connect the access point and your computer to ports on an Ethernet switch that are members of the same VLAN.

The instructions for starting the first management session are found in the following sections:

- “Starting the First Management Session with a Direct Connection” on page 65
- “Starting the First Management Session Over a Network” on page 65

Note

The first management session of the access point has to be conducted through the LAN port because the default setting for the radios is off.

Starting the First Management Session with a Direct Connection

To start the management session with a direct Ethernet connection between your computer and the LAN port on the access point, perform the following procedure:

Note

If the access point is powered only with PoE, you cannot perform this procedure because it requires a direct connection between your computer and the LAN port on the access point. Instead, perform “Starting the First Management Session Over a Network” on page 65.

1. Connect one end of a network cable to the LAN port on the access point and the other end to the Ethernet network port on your computer.
2. Change the IP address on your computer to 192.168.1.*n*, where *n* is a number from 1 to 254, but not 230. Refer to the documentation that accompanies your computer for instructions on how to set the IP address.
3. Set the subnet mask on your computer to 255.255.255.0.
4. Power on the access point.
5. Start the web browser on your computer.
6. Enter the IP address 192.168.1.230 in the URL field of the browser and press the Enter key.

You should now see the login window, shown in Figure 32 on page 67.

7. Enter “manager” for the user name and “friend” for the password. The user name and password are case-sensitive.
8. Click the Login button.

Starting the First Management Session Over a Network

This procedure explains how to start the first management session on the access point when the LAN port is connected to an Ethernet switch on a network that does not have a DHCP server. To start the management session, perform the following procedure:

1. If your network has VLANs, check to be sure that your computer and the access point are connected to ports on the Ethernet switch that are members of the same VLAN. This might require accessing the management software on the switch and listing the VLANs and their port assignments. For example, if the access point is connected to a port that is a member of the Sales VLAN, your computer must be connected to a port that is also a member of that VLAN. If your network is small and does not have VLANs or routers, you can connect your computer to any port on the Ethernet switch.

2. Change the IP address on your computer to 192.168.1.*n*, where *n* is a number from 1 to 254, but not 230. Refer to the documentation that accompanies your computer for instructions on how to set the IP address.
3. Set the subnet mask on your computer to 255.255.255.0.
4. Power on the access point.
5. Start the web browser on your computer.
6. Enter the IP address 192.168.1.230 in the URL field of the browser and press the Return key.

You should now see the logon window, shown in Figure 32 on page 67.

7. Enter “manager” for the user name and “friend” for the password. The user name and password are case-sensitive.
8. Click the Login button.

Starting a Management Session

This section explains how to start a management session on the access point from your management workstation, using a web browser. The procedure assumes that the access point has already been assigned an IP address, either manually or from a DHCP server.

Note

If the access point is using its default address 192.168.1.230, refer to “Starting the First Management Session Without a DHCP Server” on page 64 for instructions.

To start a management session on the access point, perform the following procedure:

1. Open the web browser on your management workstation.
2. Enter the IP address of the access point in the URL field of the web browser.

Note

Precede the IP address with HTTPS:// if the access point is already configured for HTTPS management. The default is HTTP management.

You should now see the log on window in Figure 32.

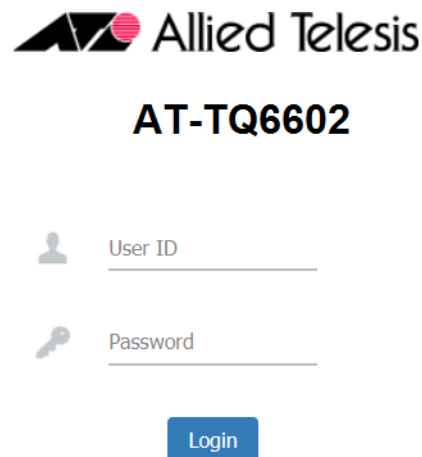

Figure 32. Log On Window

Note

If you use HTTPS management, your web browser might display a warning message stating that the site certificate is invalid. If this occurs, select an appropriate option to continue to the web site. To avoid the message in future management sessions, make the web site a trusted site in your web browser.

3. Enter the user name and password for the unit. The default values are “manager” for the user name and “friend” for the password. The user name and password are case-sensitive.
4. Click the Login button.

Appendix A

Technical Specifications

This appendix contains the specifications for the TQ6602 Wireless Access Point in the following sections:

- “Physical Specifications”
- “Environmental Specifications”
- “Power Specifications” on page 70
- “Cable Specifications” on page 71
- “LAN Ports Specifications and Pinouts” on page 72

Physical Specifications

Table 2. Physical Specifications

Parameter	Specification
Dimensions (W x D x H)	205 mm X 225 mm X 51 mm (8.07 in. x 8.86 in. x 2.01 in.)
Weight without mounting bracket	1.6 kg (3.5 lbs)
Weight with mounting bracket	1.8 kg (4.0 lbs)

Environmental Specifications

Table 3. Environmental Specifications

Parameter	Specification
Operating Temperature when powered by AC/DC adapter	0° C to 50° C (32° F to 122° F)
Operating Temperature when powered by PoE power source	0° C to 50° C (32° F to 122° F)
Storage Temperature	- 25° C to 70° C (- 13° F to 158° F)
Operating Humidity	5% to 90% non-condensing
Storage Humidity	5% to 95% non-condensing
Maximum Operating Altitude	3000 m (9843 ft)

Power Specifications

Input Power Specifications

Table 4 lists the power requirements of the TQ6602 Wireless Access Point.

Table 4. Input Power Specifications

Parameter	Specification
Rated Input Voltage	+12 VDC
Maximum Input Current	4A
Average Input Current	1.26A

External AC/DC Power Adapter Specifications

Table 5 lists the power requirements for an external AC/DC power adapter.

Table 5. External AC/DC Power Adapter Specifications

Parameter	Specification
Input Voltage Range	100~240 VAC
Input Frequency	50 - 60 Hz
Rated Output Voltage	+12 VDC
Rated Output Current	0-4.0A

Note

Allied Telesis recommends the PWRADP-01 (DA-48Z12) AC/DC power adapter. It is UL Listed and fully compatible with the above specifications, while meeting the standards of a separated extra-low voltage (SELV) product. The adapter is sold separately.

PoE+ Power Requirements

Table 6 lists the PoE+ specifications for the Ethernet port.

Table 6. PoE Power Requirements on the Ethernet Port

Parameter	Specification
Power	20.29 watts
PoE+ Device Classification	Class 4

Cable Specifications

The minimum cable requirements for the Ethernet port are listed here.

- ❑ 10/100Mbps: Standard TIA/EIA 568-B-compliant Category 3 shielded or unshielded cabling.
- ❑ 1/2.5/5Gbps: Standard TIA/EIA 568-A-compliant Category 5 or TIA/EIA 568-B-compliant Enhanced Category 5 (Cat 5e) shielded or unshielded cabling.

The maximum operating distance is 100 meters (328 feet).

LAN Ports Specifications and Pinouts

Port Specifications

The access point port specifications are shown in Table 7.

Table 7. LAN Port Specifications

Connector	Specification
Standards	IEEE 802.3 (10Base-T) IEEE 802.3u (100Base-TX) IEEE 802.3ab (1000Base-T) IEEE 802.3bz (2.5Base-T) IEEE 802.3bz (5Base-T)
PoE standard	IEEE 802.3at (class tbd)

Port Pinouts

The pin signal definitions for the Ethernet port are given here. Figure 33 illustrates the pin layout of the port.

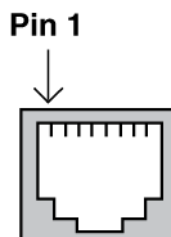

Figure 33. Pin Layout for RJ45 Connector on the Ethernet Port

Table 8 lists the pin signals for ports operating at 10/100Mbps in the MDI configuration.

Table 8. MDI Pin Signals at 10/100Mbps

Pin	Signal
1	TX+
2	TX-
3	RX+
6	RX-

Table 9 lists the pin signals for ports operating at 10/100Mbps in the MDIX configuration.

Table 9. MDIX Pin Signals at 10/100Mbps

Pin	Signal
1	RX+
2	RX-
3	TX+
6	TX-

Table 10 lists the pin signals for LAN ports operating at 1/2.5/5Gbps.

Table 10. Connector Pinouts at 1/2.5/5Gbps

Pin	Pair	Signal
1	1	TX and RX
2	1	TX and RX-
3	2	TX and RX+
4	3	TX and RX+
5	3	TX and RX-
6	2	TX and RX-
7	4	TX and RX+
8	4	TX and RX-

Appendix B

Regulatory Statements

This appendix contains the following regulatory statements:

- ❑ “Federal Communication Commission Interference Statement” on page 76
- ❑ “Industry Canada Statement” on page 78
- ❑ “Europe - EU Declaration of Conformity” on page 80
- ❑ “UK - UKCA Declaration of Conformity” on page 81

Federal Communication Commission Interference Statement

This device complies with Part 15 of the FCC Rules. Operation is subject to the following two conditions: (1) This device may not cause harmful interference, and (2) this device must accept any interference received, including interference that may cause undesired operation.

This equipment has been tested and found to comply with the limits for a Class B digital device, pursuant to Part 15 of the FCC Rules. These limits are designed to provide reasonable protection against harmful interference in a residential installation. This equipment generates, uses and can radiate radio frequency energy and, if not installed and used in accordance with the instructions, may cause harmful interference to radio communications. However, there is no guarantee that interference will not occur in a particular installation. If this equipment does cause harmful interference to radio or television reception, which can be determined by turning the equipment off and on, the user is encouraged to try to correct the interference by one of the following measures:

- Reorient or relocate the receiving antenna.
- Increase the separation between the equipment and receiver.
- Connect the equipment into an outlet on a circuit different from that to which the receiver is connected.
- Consult the dealer or an experienced radio/TV technician for help.



Caution

FCC Caution: Any changes or modifications not expressly approved by the party responsible for compliance could void the user's authority to operate this equipment. ⚡ E80



Caution

Avertissement de la FCC: Les changements ou modifications non expressément approuvés par la partie responsable de la conformité pourraient annuler l'autorité de l'utilisateur à utiliser cet équipement. ⚡ E80

This transmitter must not be co-located or operating in conjunction with any other antenna or transmitter.

For operation within 5.15 ~ 5.25GHz / 5.47 ~5.725GHz frequency range, it is restricted to indoor environment. The band from 5600-5650MHz will be disabled by the software during the manufacturing and cannot be changed by the end user. This device meets all the other requirements specified in Part 15E, Section 15.407 of the FCC Rules.

Radiation Exposure Statement

This equipment complies with FCC radiation exposure limits set forth for an uncontrolled environment. This equipment should be installed and operated with minimum distance 20 cm between the radiator & your body.

Industry Canada Statement

This device contains licence-exempt transmitter(s)/receiver(s) that comply with Innovation, Science and Economic Development Canada's licence-exempt RSS(s). Operation is subject to the following two conditions:

- (1) This device may not cause interference.
- (2) This device must accept any interference, including interference that may cause undesired operation of the device.

L'émetteur/récepteur exempt de licence contenu dans le présent appareil est conforme aux CNR d'Innovation, Sciences et Développement économique Canada applicables aux appareils radio exempts de licence. L'exploitation est autorisée aux deux conditions suivantes:

- (1) L'appareil ne doit pas produire de brouillage.
- (2) L'appareil doit accepter tout brouillage radioélectrique subi, même si le brouillage est susceptible d'en compromettre le fonctionnement.

This Class B digital apparatus complies with Canadian ICES-003.

Cet appareil numérique de la Class B est conforme à la norme NMB-003 du Canada.

Caution:

- (i) the device for operation in the band 5150-5250 MHz is only for indoor use to reduce the potential for harmful interference to co-channel mobile satellite systems;
- (ii) the maximum antenna gain permitted for devices in the bands 5250-5350 MHz and 5470-5725 MHz shall be such that the equipment still complies with the e.i.r.p. limit;
- (iii) the maximum antenna gain permitted for devices in the band 5725-5850 MHz shall be such that the equipment still complies with the e.i.r.p. limits specified for point-to-point and non-point-to-point operation as appropriate;
- (iv) the worst-case tilt angle(s) necessary to remain compliant with the e.i.r.p. elevation mask requirement set forth in Section 6.2.2(3) shall be clearly indicated; and
- (v) Users should also be advised that high-power radars are allocated as primary users (i.e., priority users) of the bands 5250-5350 MHz and 5650-5850 MHz and that these radars could cause interference and/or damage to LE-LAN devices.

Avertissement:

Le guide d'utilisation des dispositifs pour réseaux locaux doit inclure des instructions précises sur les restrictions susmentionnées, notamment:

- (i) les dispositifs fonctionnant dans la bande 5150-5250 MHz sont réservés uniquement pour une utilisation à l'intérieur afin de réduire les risques de brouillage préjudiciable aux systèmes de satellites mobiles utilisant les mêmes canaux;
- (ii) le gain maximal d'antenne permis pour les dispositifs utilisant les bandes de 5250 à 5350 MHz et de 5470 à 5725 MHz doit être conforme à la limite de la p.i.r.e.;
- (iii) le gain maximal d'antenne permis (pour les dispositifs utilisant la bande de 5725 à 5850 MHz) doit être conforme à la limite de la p.i.r.e. spécifiée pour l'exploitation point à point et l'exploitation non point à point, selon le cas;
- (iv) les pires angles d'inclinaison nécessaires pour rester conforme à l'exigence de la p.i.r.e. applicable au masque d'élévation, et énoncée à la section 6.2.2 3), doivent être clairement indiqués;
- (v) De plus, les utilisateurs devraient aussi être avisés que les utilisateurs de radars de haute puissance sont désignés utilisateurs principaux (c.-à-d., qu'ils ont la priorité) pour les bandes 5250-5350 MHz et 5650-5850 MHz et que ces radars pourraient causer du brouillage et/ou des dommages aux dispositifs LAN-EL.

Radiation Exposure Statement:

This equipment complies with ISED radiation exposure limits set forth for an uncontrolled environment. This equipment should be installed and operated with minimum distance 20cm between the radiator & your body.

Déclaration d'exposition aux radiations:

Cet équipement est conforme aux limites d'exposition aux rayonnements ISED établies pour un environnement non contrôlé. Cet équipement doit être installé et utilisé avec un minimum de 20cm de distance entre la source de rayonnement et votre corps.

Europe - EU Declaration of Conformity

Operating Frequencies and Maximum Transmission Power Levels

Hereby, Allied Telesis declares that the radio equipment type [TQ6602] is in compliance with Directive 2014/53/EU.

The operating frequencies and maximum transmission power levels for wireless devices operated in the EU are listed below:

- 2412-2472 MHz:
19.08 dBm (Beamforming), 19.08 dBm (Non-Beamforming)
- 5150-5250 MHz:
22.10 dBm (Beamforming), 22.18 dBm (Non-Beamforming)
- 5250-5350 MHz:
22.11 dBm (Beamforming), 22.10 dBm (Non-Beamforming)
- 5470-5725 MHz:
29.18 dBm (Beamforming), 27.08 dBm (Non-Beamforming)

Note

Operations in the 5.15 - 5.35 GHz band are restricted to indoor usage only.

Radiation Exposure Statement

This equipment complies with EU radiation exposure limits set forth for an uncontrolled environment. This equipment should be installed and operated with a minimum distance of 20 cm between the radiator and your body.



AT	BE	BG	CH	CY	CZ	DE	DK	EE
EL	ES	FI	FR	HR	HU	IE	IS	IT
LI	LT	LU	LV	MT	NL	NO	PL	PT
RO	SE	SI	SK	TR	UK(NI)			

Importer

Allied Telesis International BV
Incheonweg 7, 1437 EK Rozenburg

Note

Contact Allied Telesis for the EU conformity statement. To contact Allied Telesis, visit our web site at www.alliedtelesis.com/contact.

UK - UKCA Declaration of Conformity

Hereby, Allied Telesis declares that the radio equipment type [AT-TQ6602] is in compliance with The Radio Equipment Regulations 2017.

Operating Frequencies and Maximum Transmission Power Levels

The operating frequencies and maximum transmission power levels for wireless devices operated in the UKCA are listed below:

- 2412-2472 MHz:
19.08 dBm (Beamforming), 19.08 dBm (Non-Beamforming)
- 5150-5250 MHz:
22.10 dBm (Beamforming), 22.18 dBm (Non-Beamforming)
- 5250-5350 MHz:
22.11 dBm (Beamforming), 22.10 dBm (Non-Beamforming)
- 5470-5725 MHz:
29.18 dBm (Beamforming), 27.08 dBm (Non-Beamforming)

Note

Operations in the 5.15 - 5.35 GHz band are restricted to indoor usage only.

Radiation Exposure Statement

This equipment complies with EU radiation exposure limits set forth for an uncontrolled environment. This equipment should be installed and operated with a minimum distance of 20 cm between the radiator and your body.



Importer

Allied Telesis International BV 11 Pine Court, Kembrey Park
Swindon Wiltshire SN2 8AD, United Kingdom

Note

Contact Allied Telesis for the UK conformity statement. To contact Allied Telesis, visit our web site at www.alliedtelesis.com/contact.

Appendix C

Radiation Patterns

This appendix contains the following sections:

- “2.4GHz Antenna 1” on page 84
- “2.4GHz Antenna 2” on page 87
- “2.4GHz Antenna 3” on page 90
- “2.4GHz Antenna 4” on page 93
- “5GHz Antenna 1” on page 96
- “5GHz Antenna 2” on page 99
- “5GHz Antenna 3” on page 102
- “5GHz Antenna 4” on page 105

2.4GHz Antenna 1

X - Z Plane (E-total)

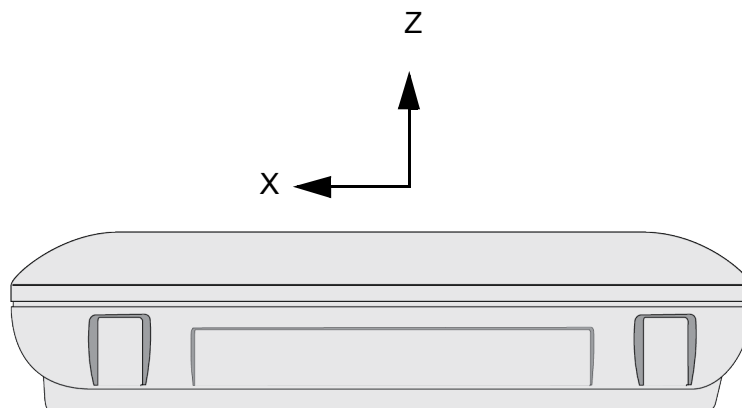
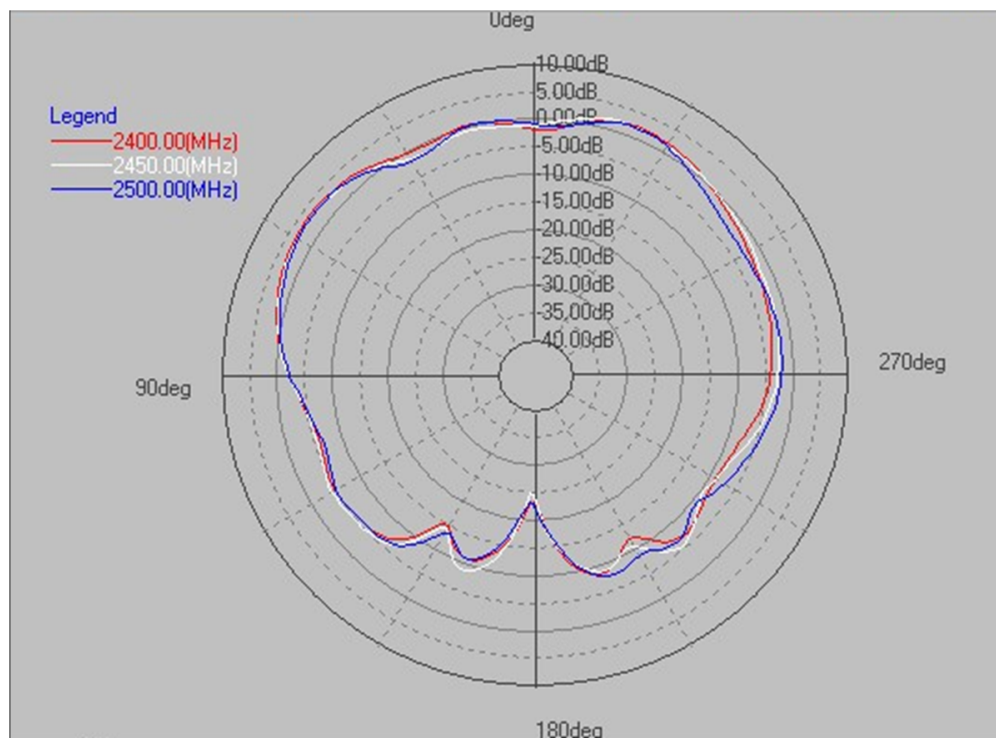

Y - Z Plane (E-total)

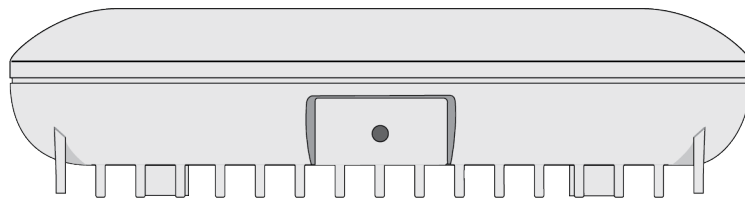
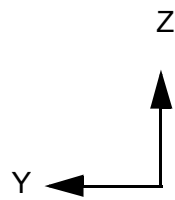
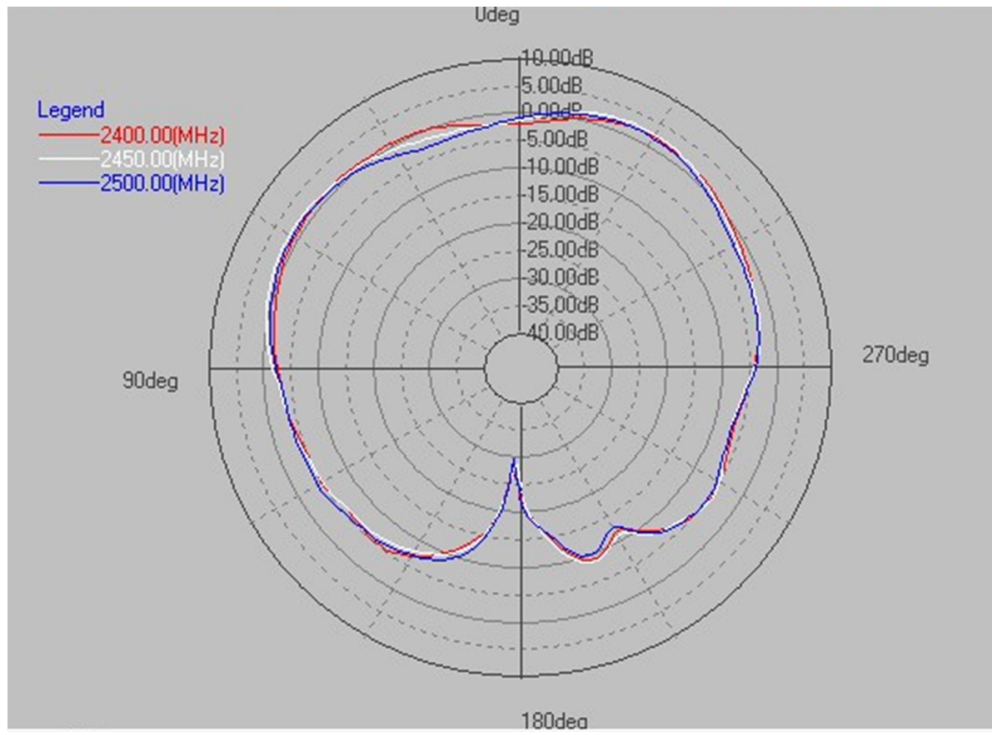

X - Y Plane (E-total)

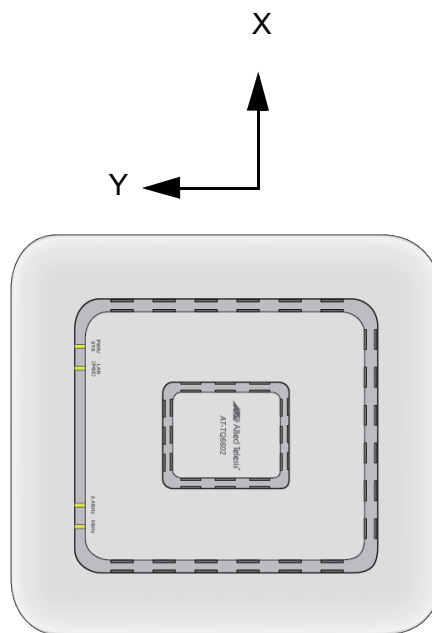
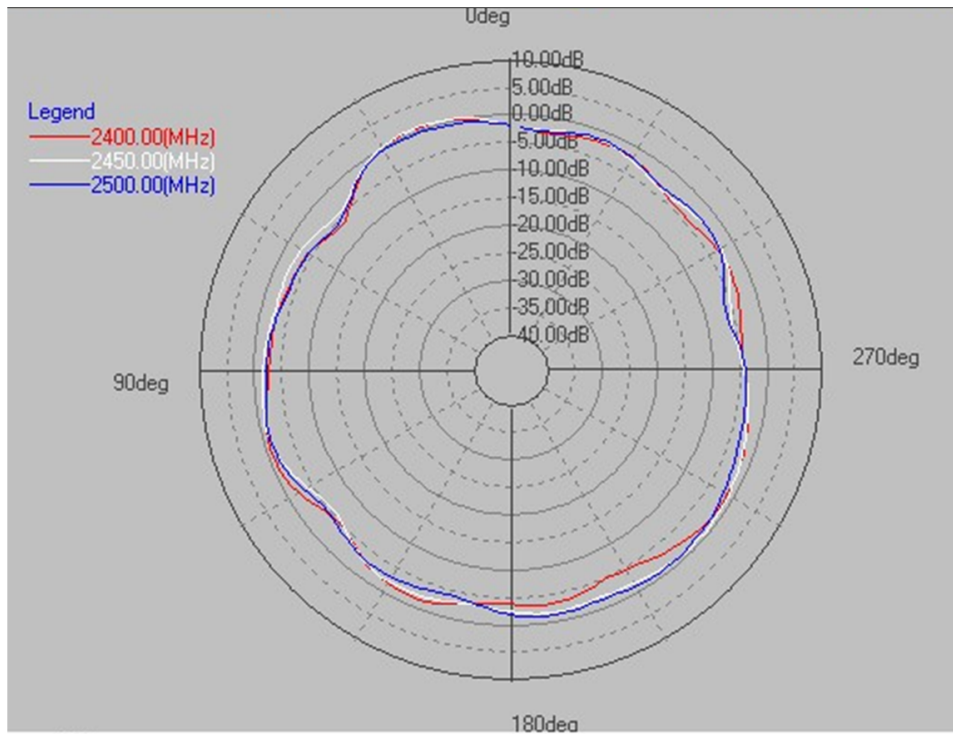

2.4GHz Antenna 2

X - Z Plane (E-total)

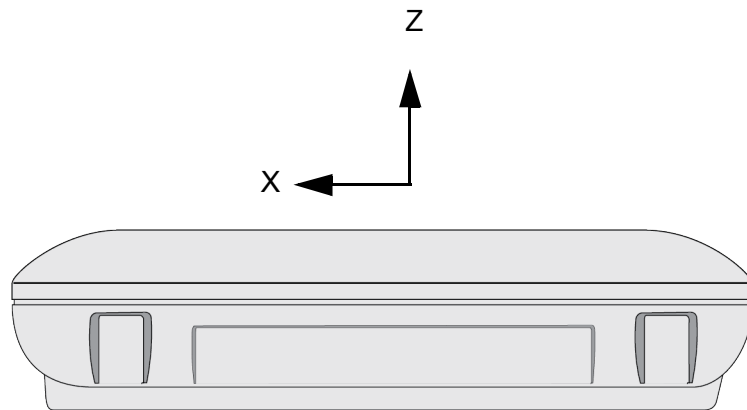
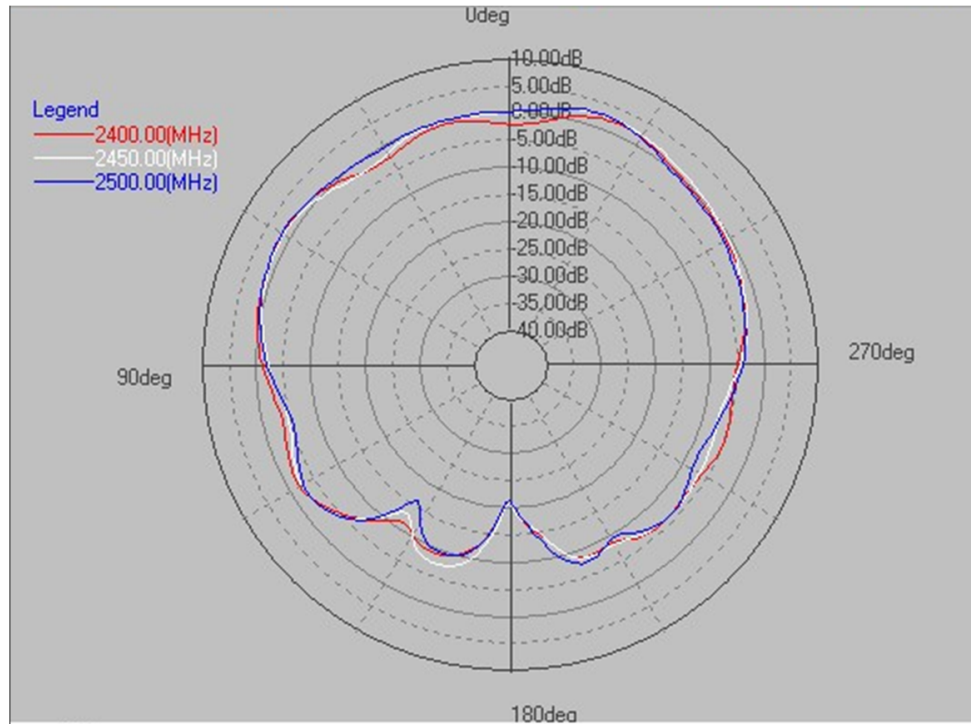

Y - Z Plane (E-total)

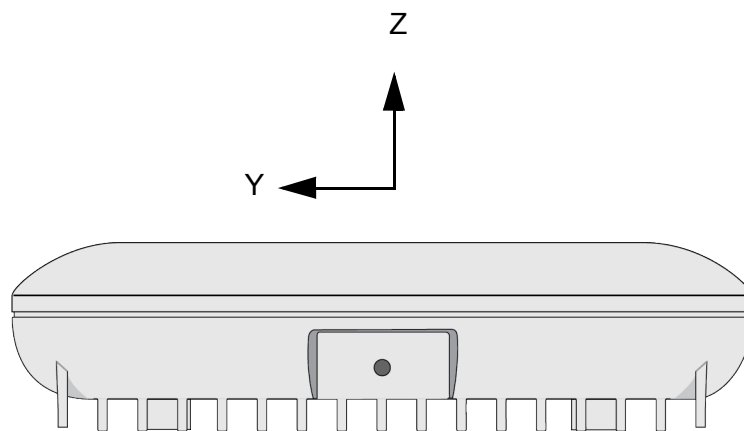
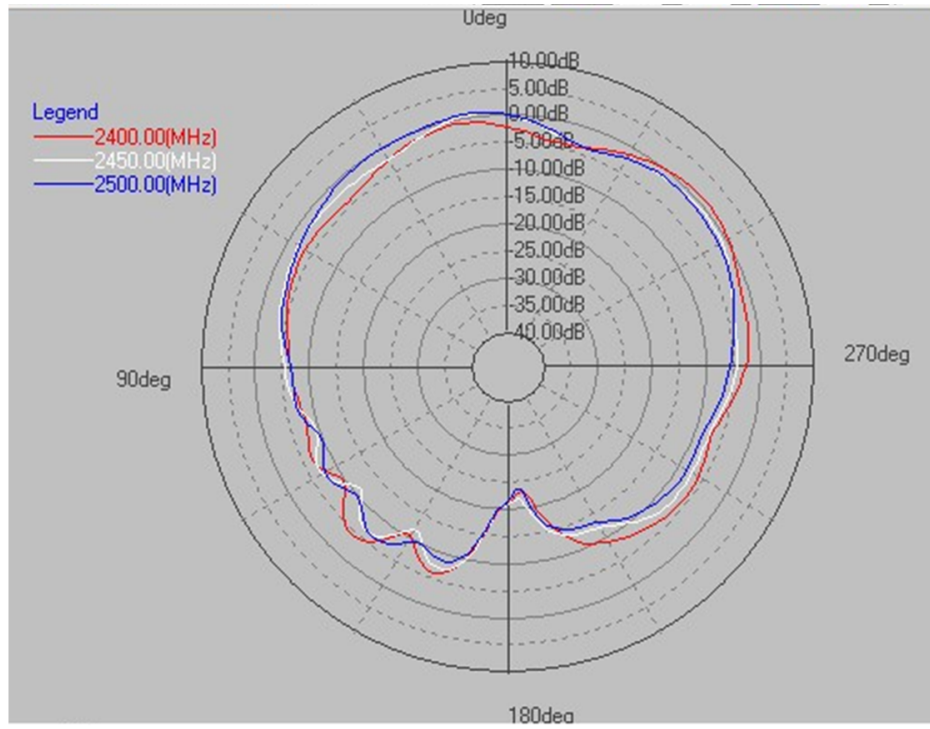

X - Y Plane (E-total)

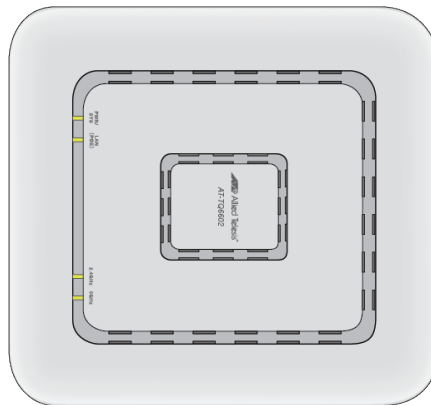
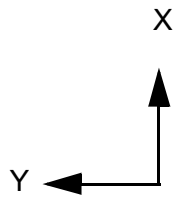
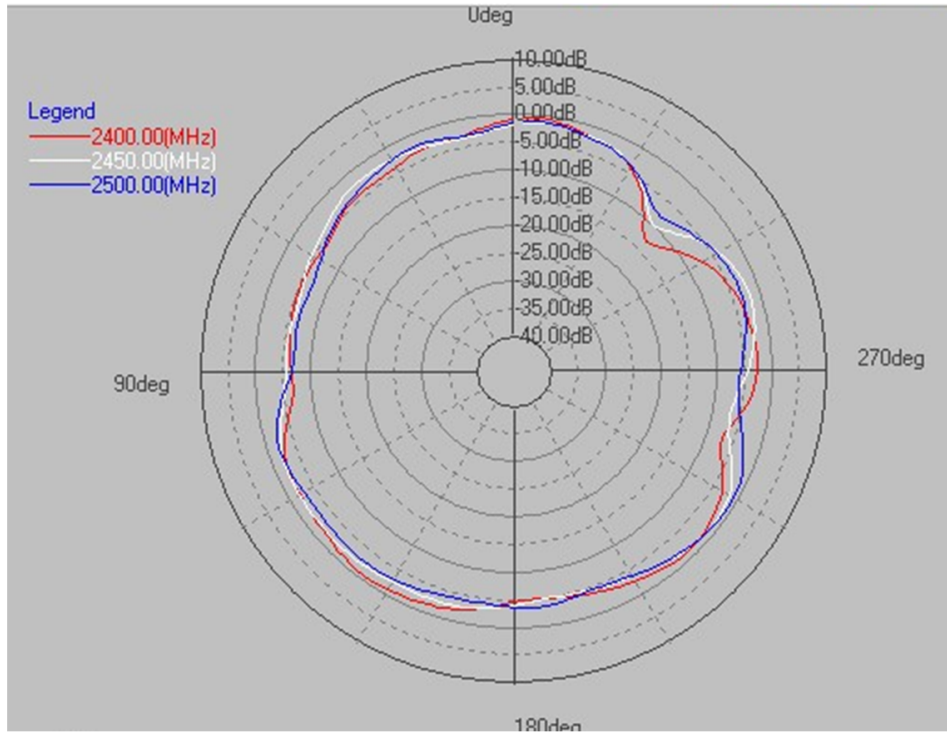

2.4GHz Antenna 3

X - Z Plane (E-total)

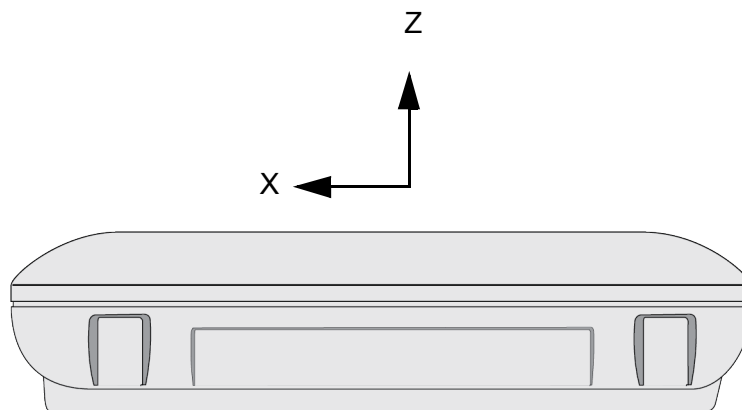
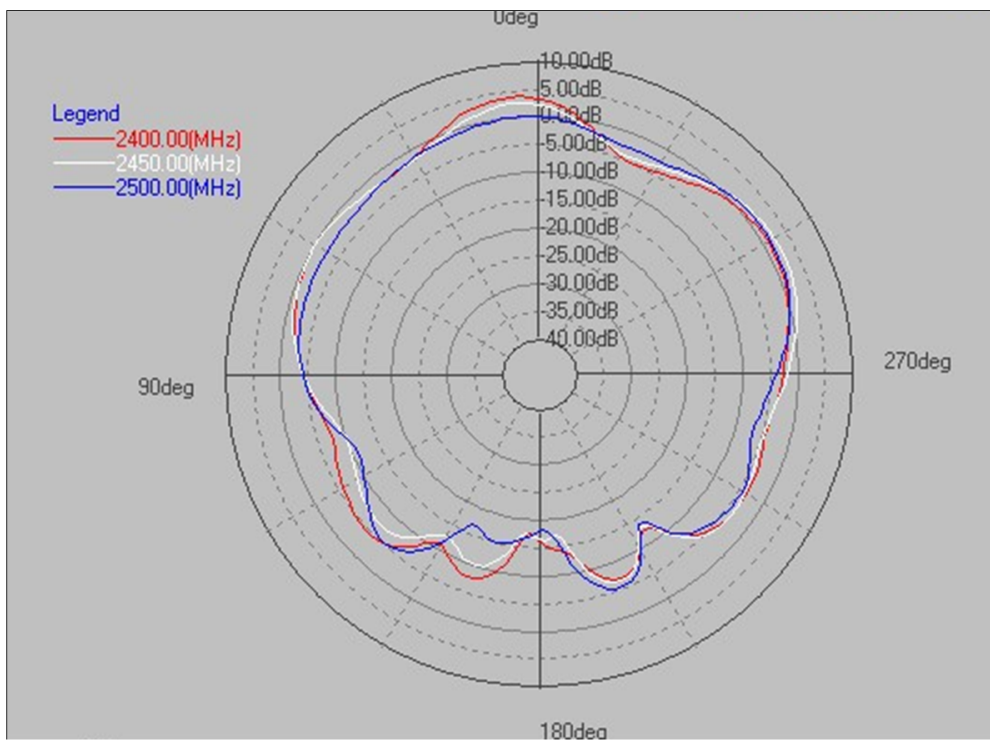

Y - Z Plane (E-total)

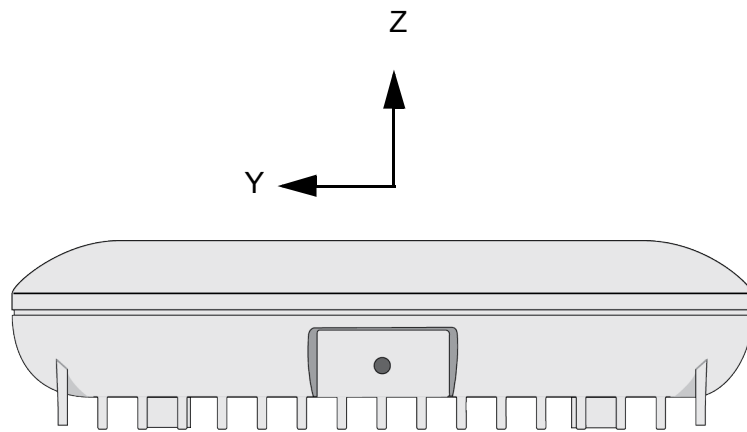
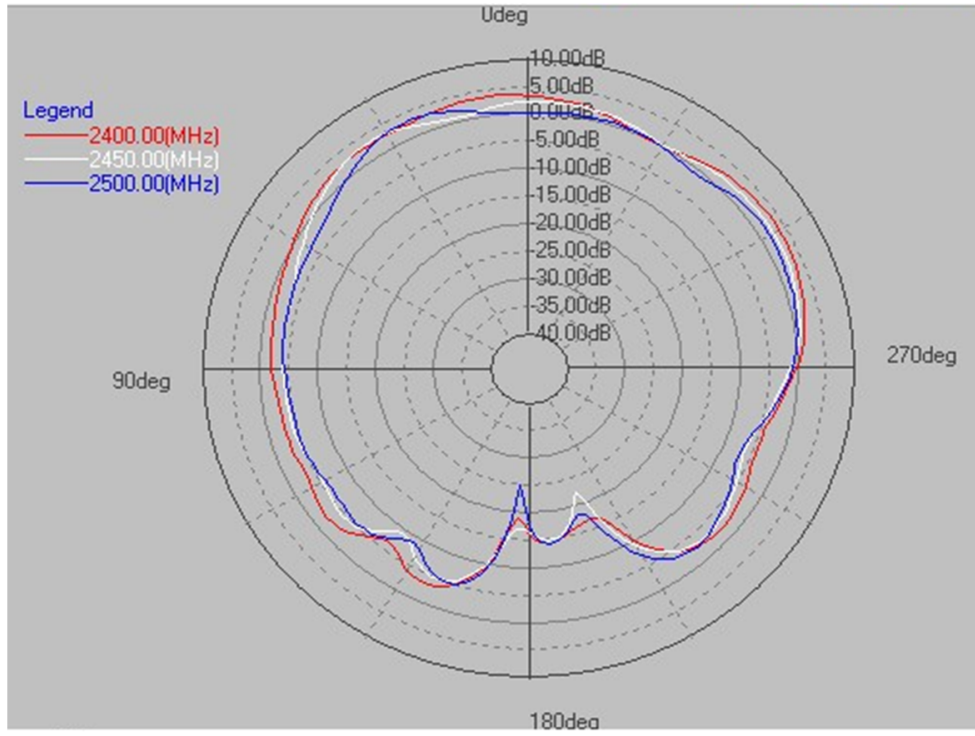

X - Y Plane (E-total)

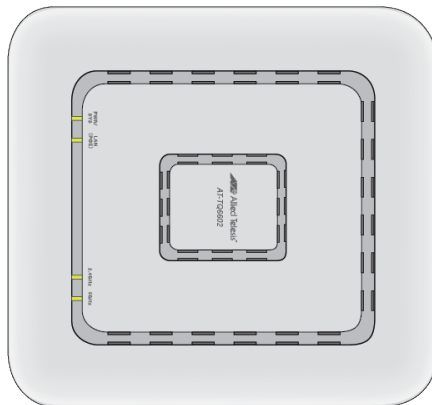
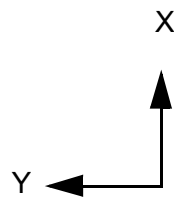
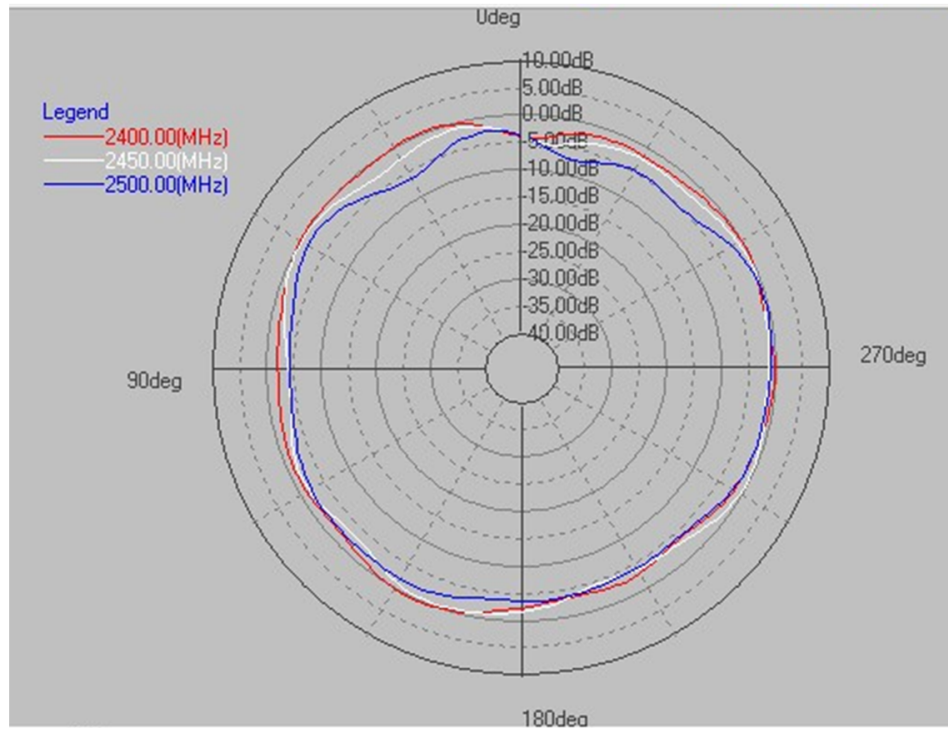

2.4GHz Antenna 4

X - Z Plane (E-total)

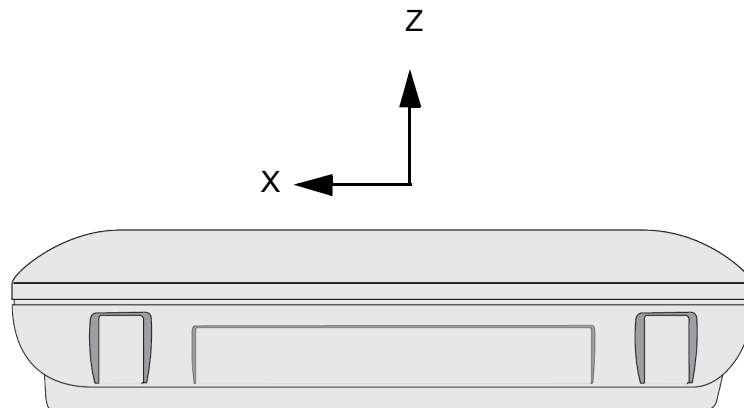
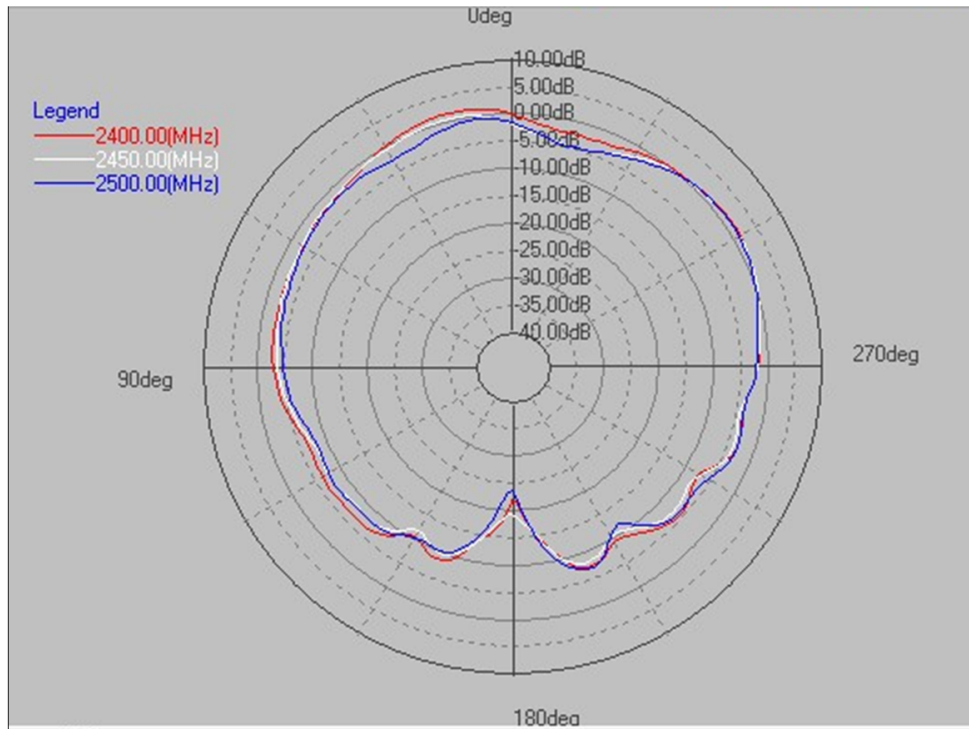

Y - Z Plane (E-total)

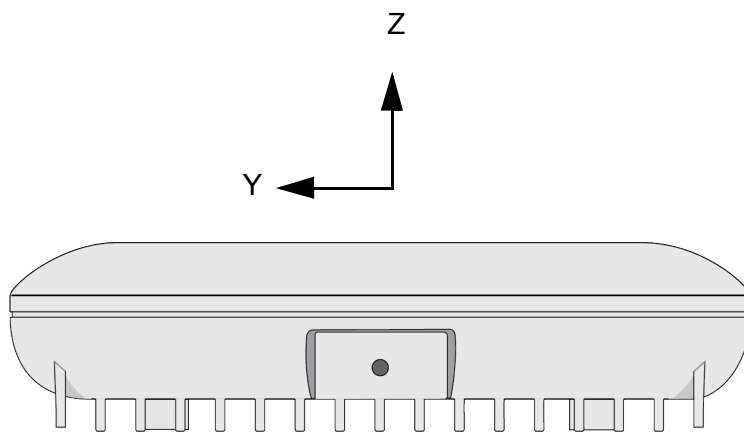
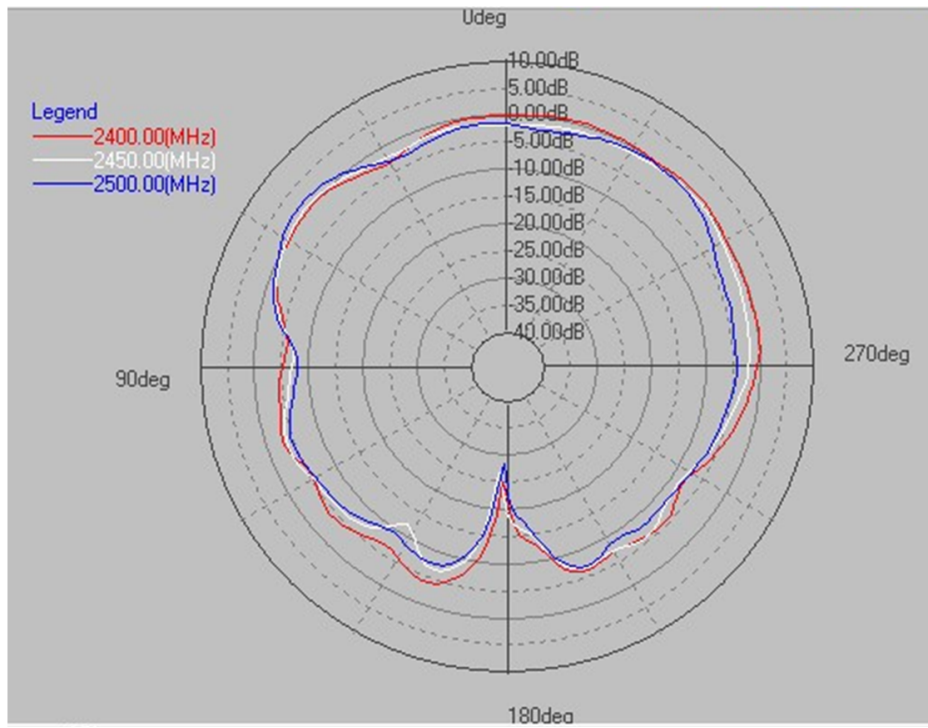

X - Y Plane (E-total)

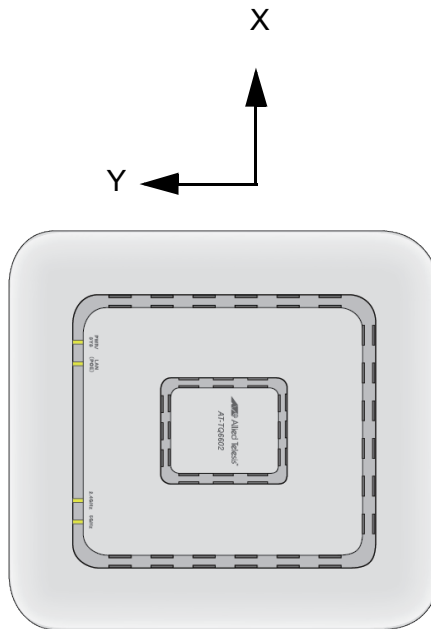
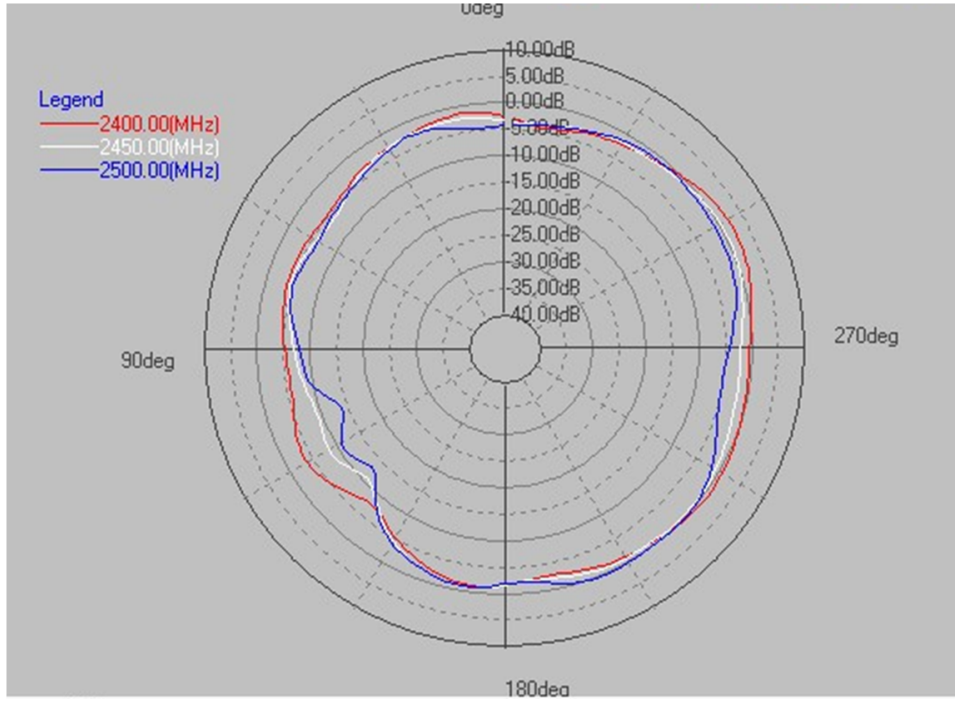

5GHz Antenna 1

X - Z Plane (E-total)

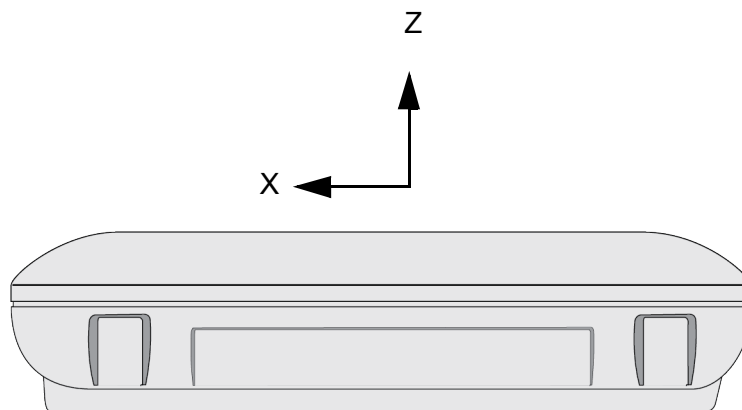
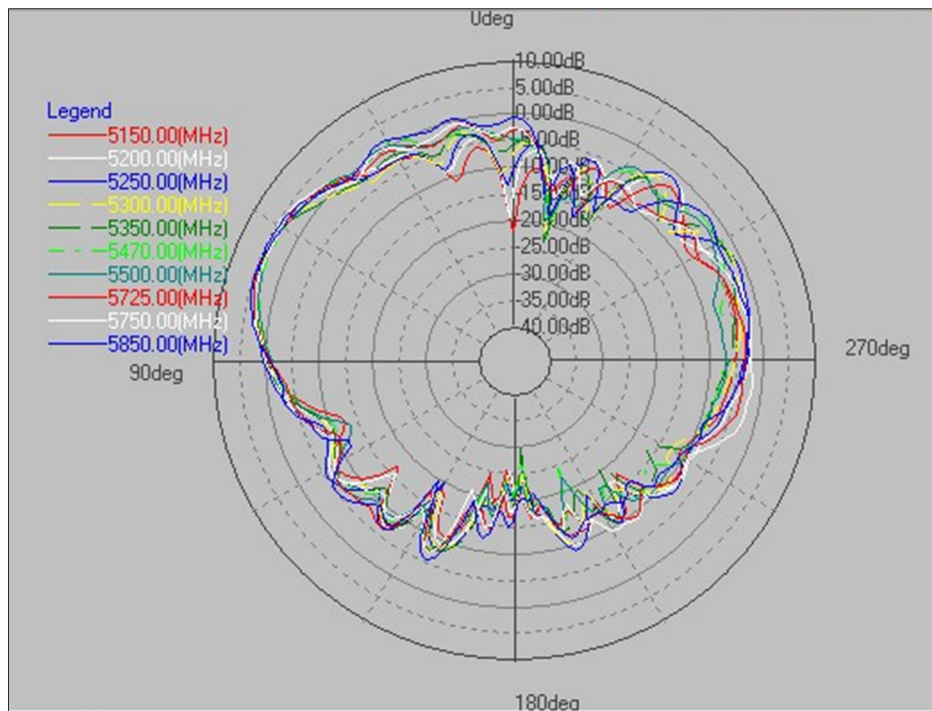

Y - Z Plane (E-total)

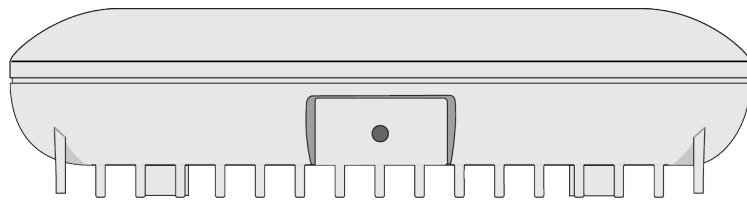
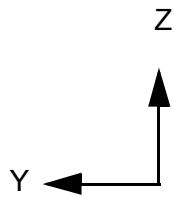
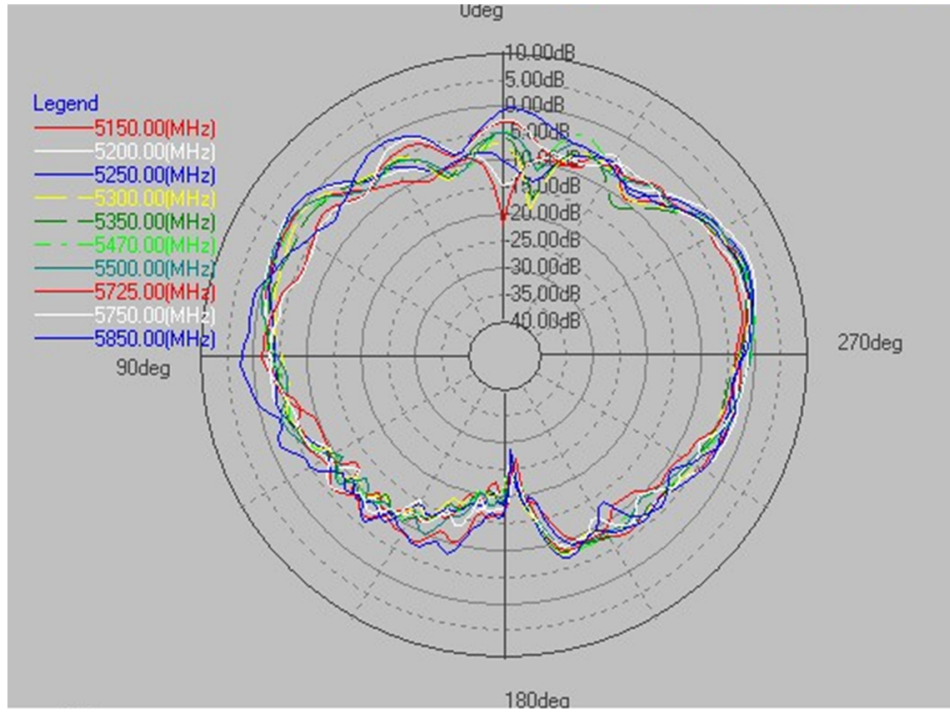

X - Y Plane (E-total)

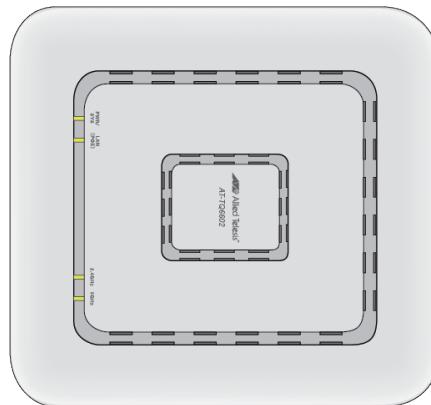
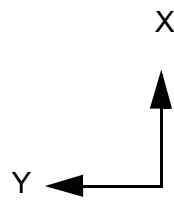
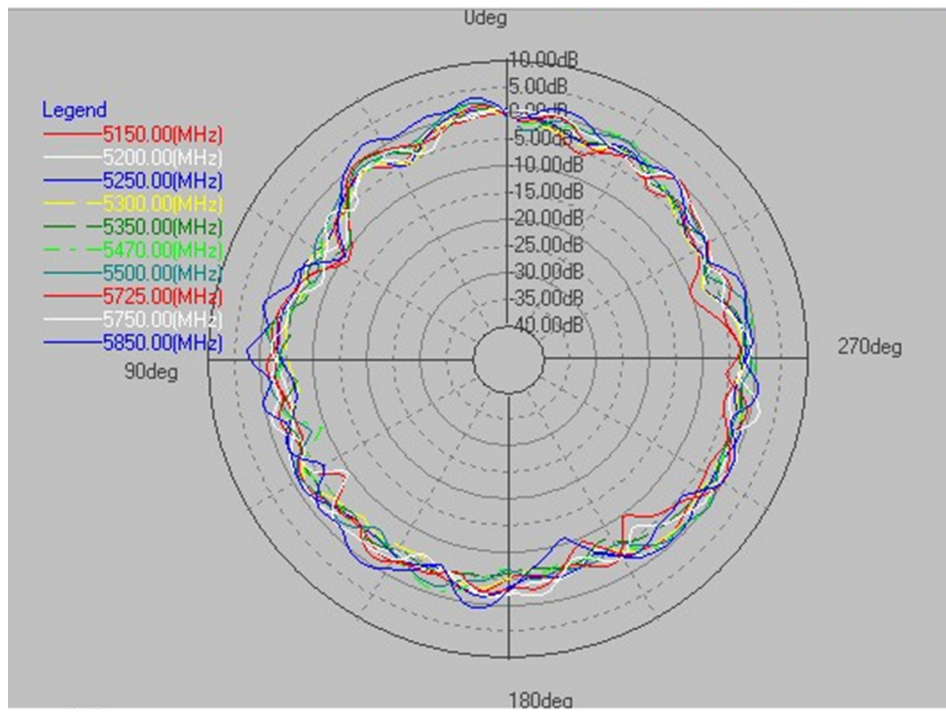

5GHz Antenna 2

X - Z Plane (E-total)

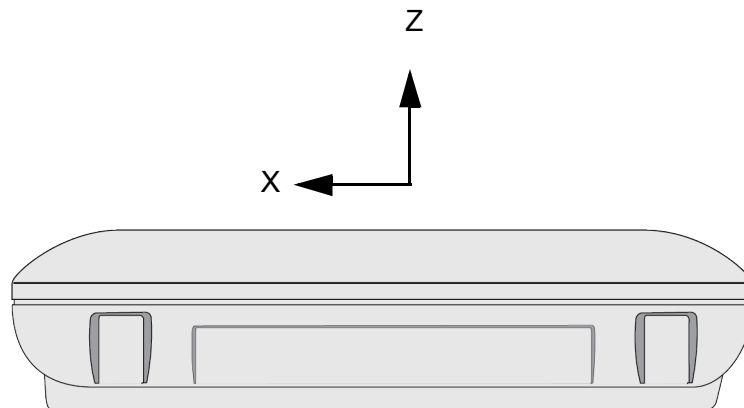
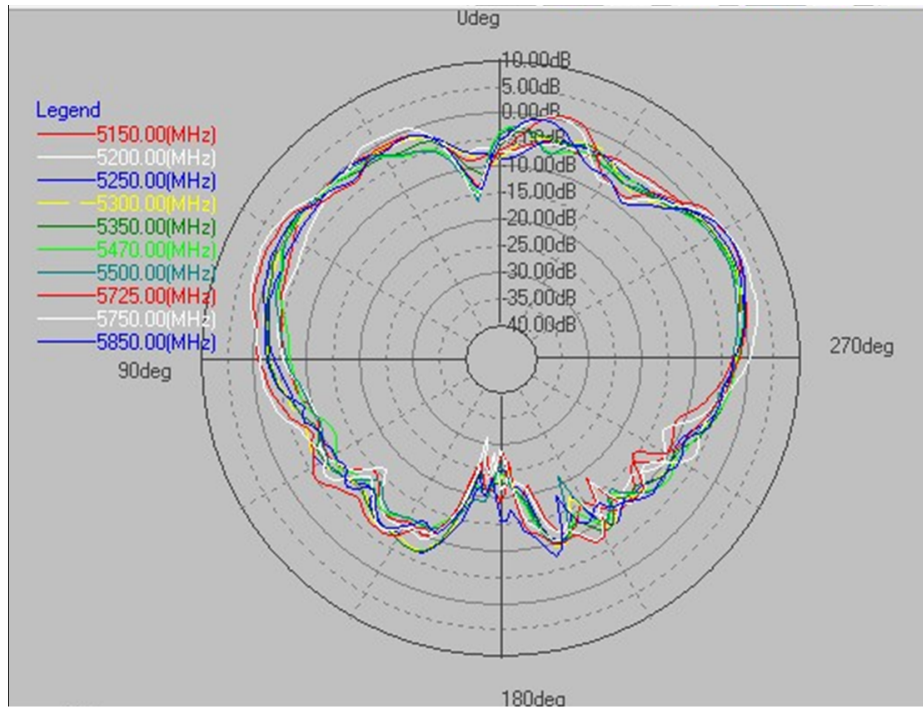

Y - Z Plane (E-total)

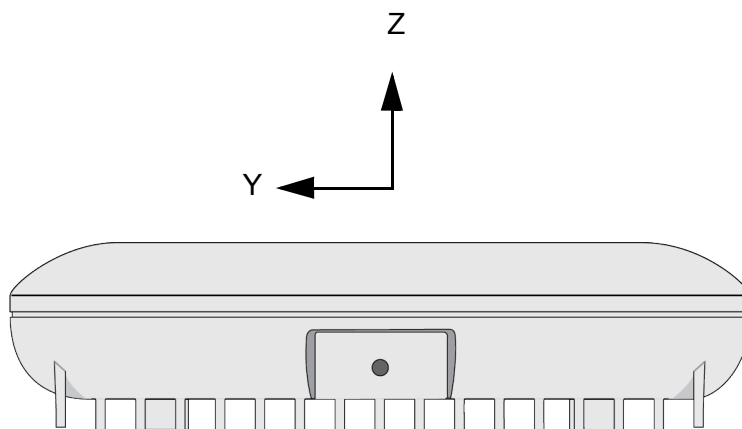
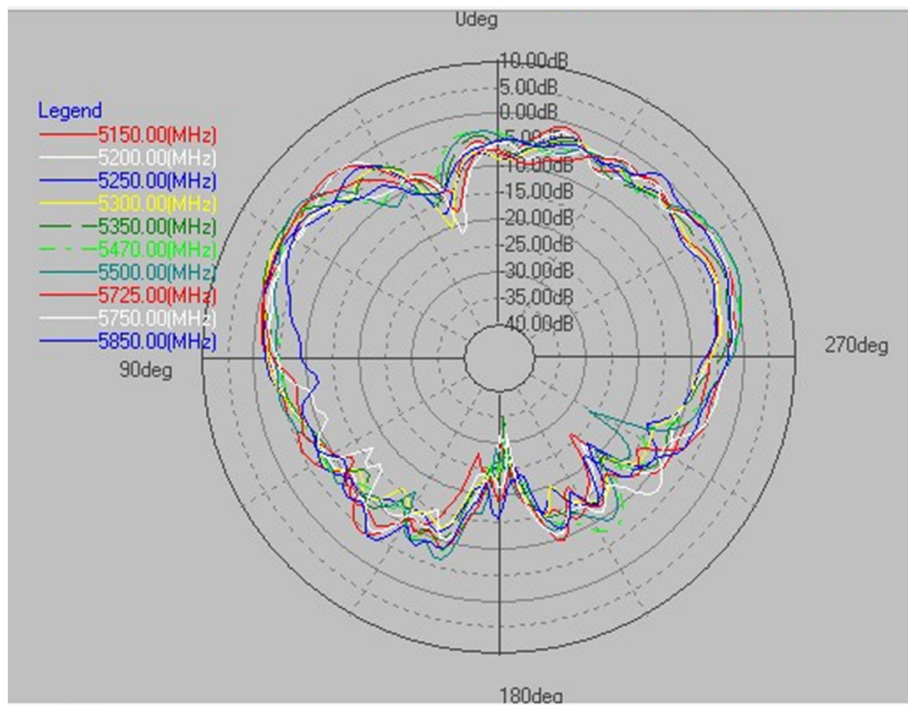

X - Y Plane (E-total)

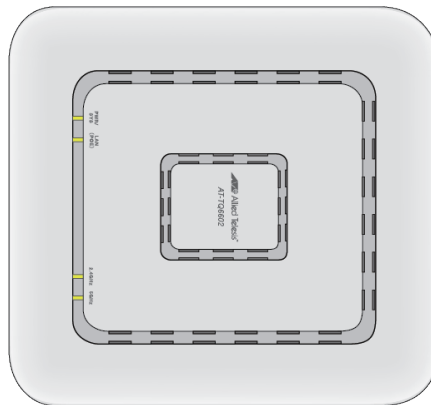
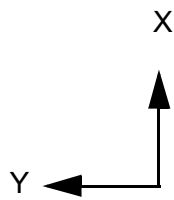
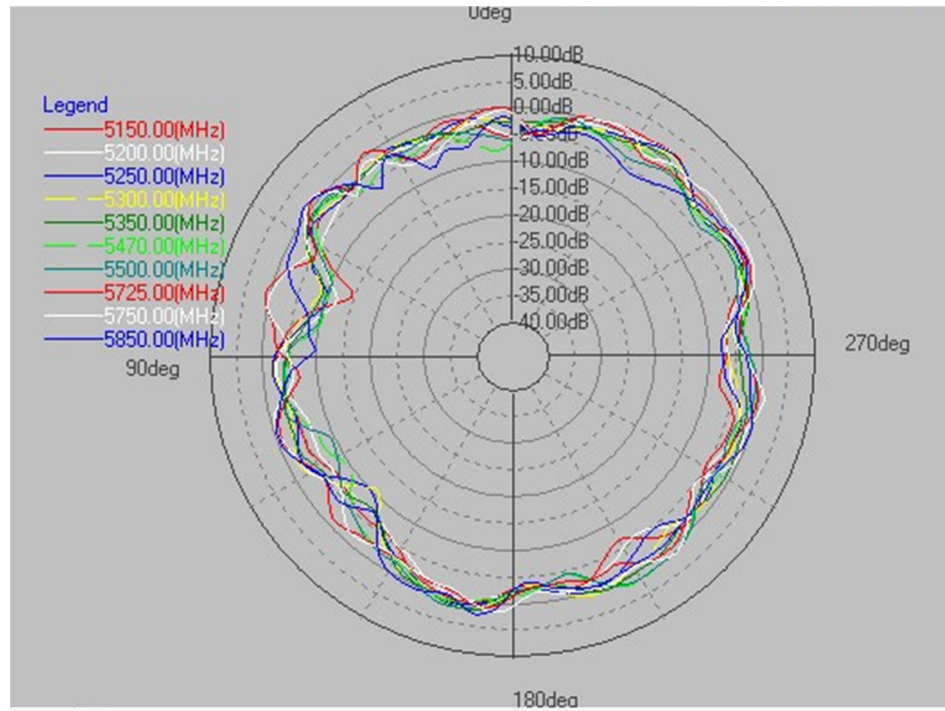

5GHz Antenna 3

X - Z Plane (E-total)

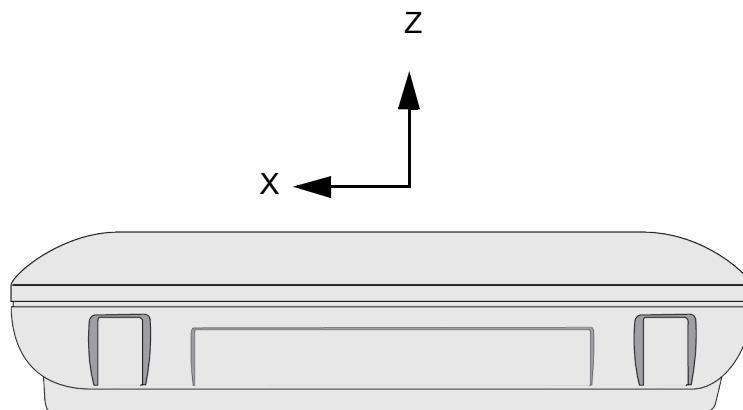
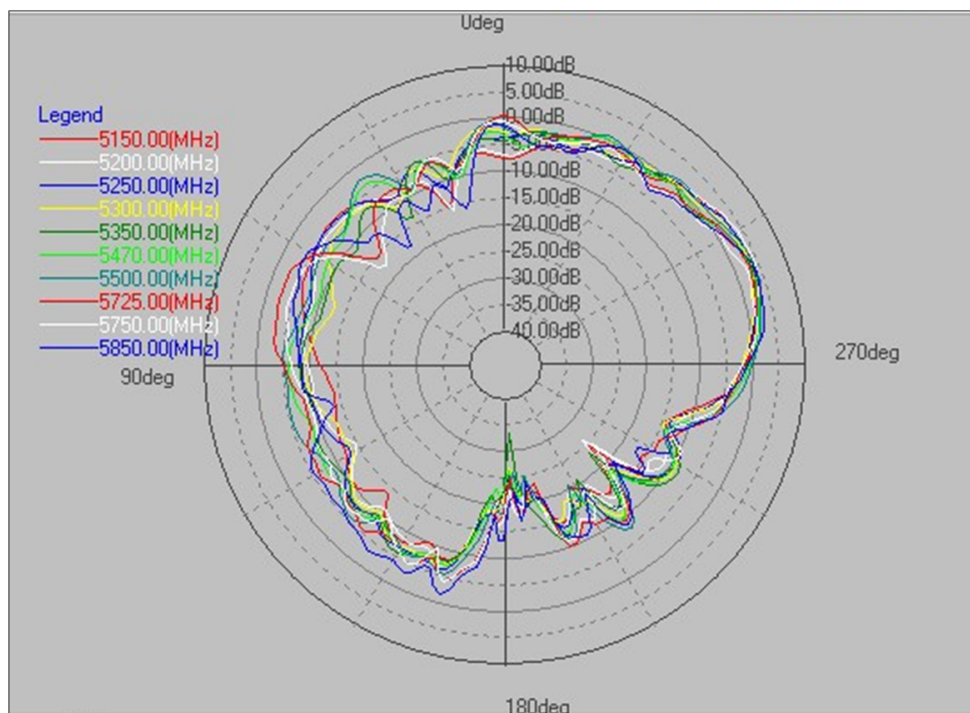

Y - Z Plane (E-total)

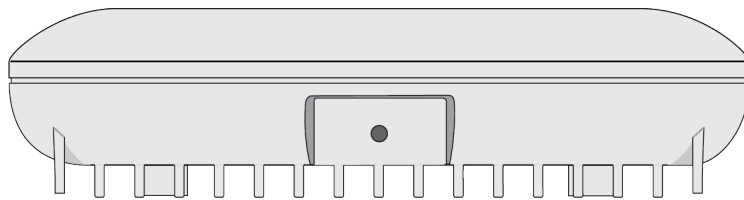
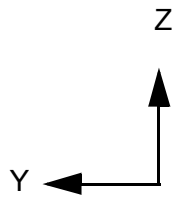
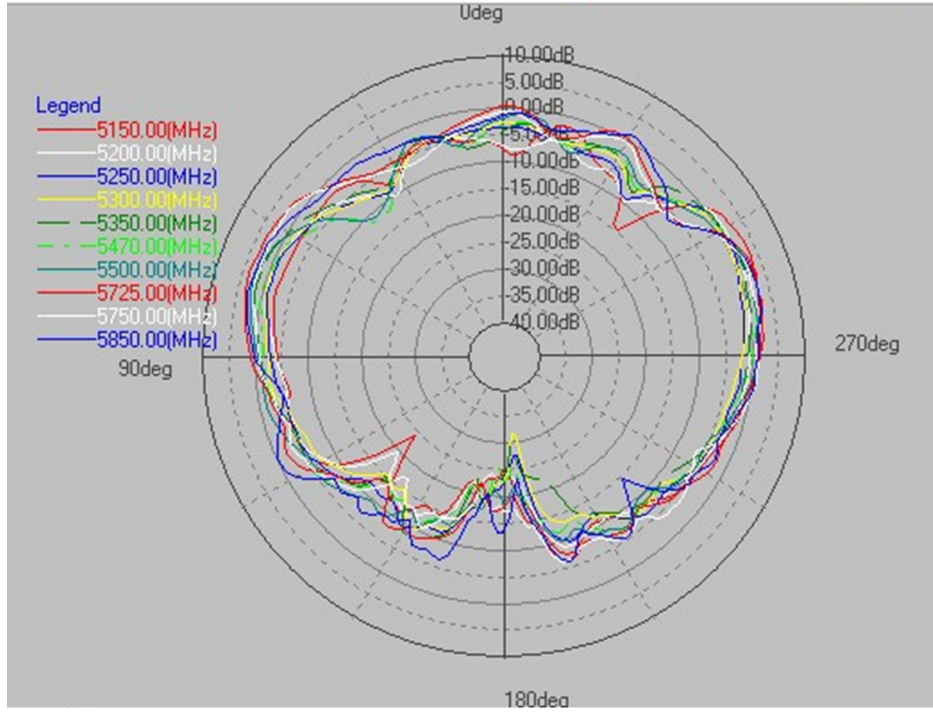

X - Y Plane (E-total)

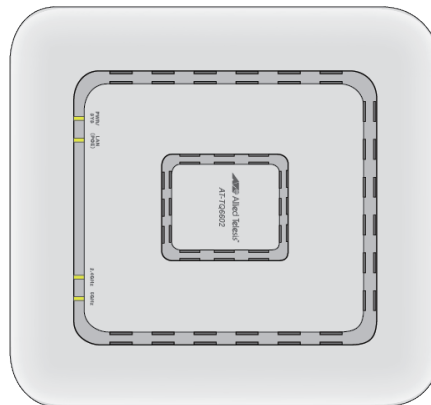
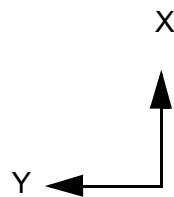
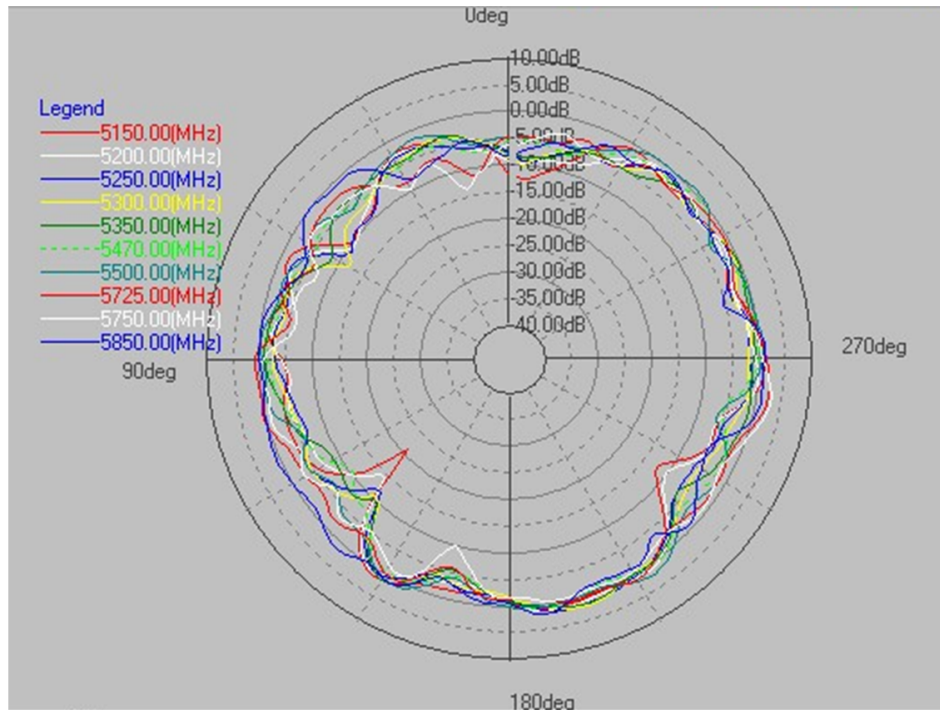

5GHz Antenna 4

X - Z Plane (E-total)

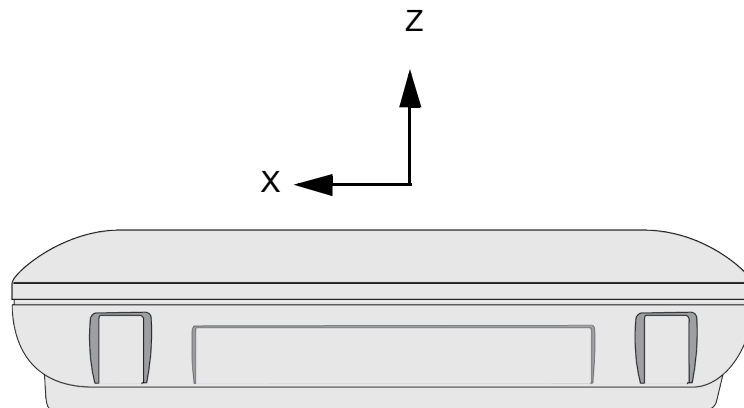
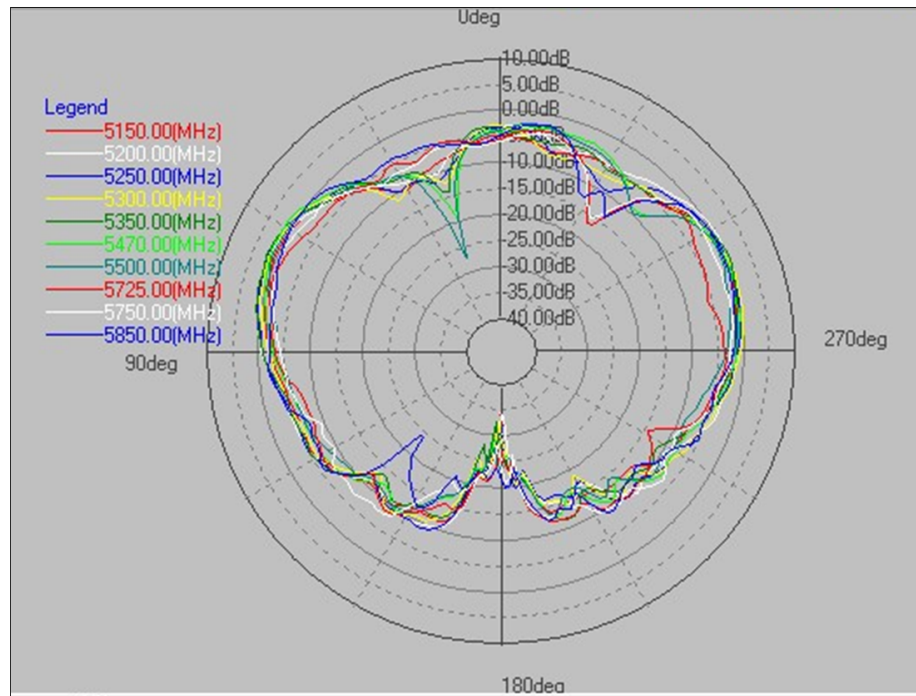

Y - Z Plane (E-total)

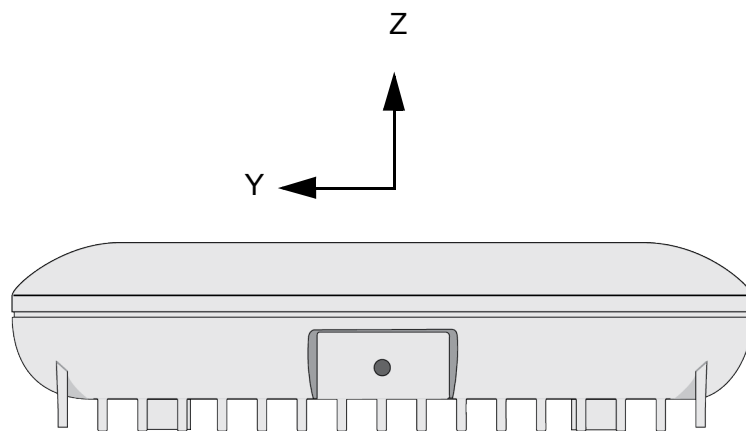
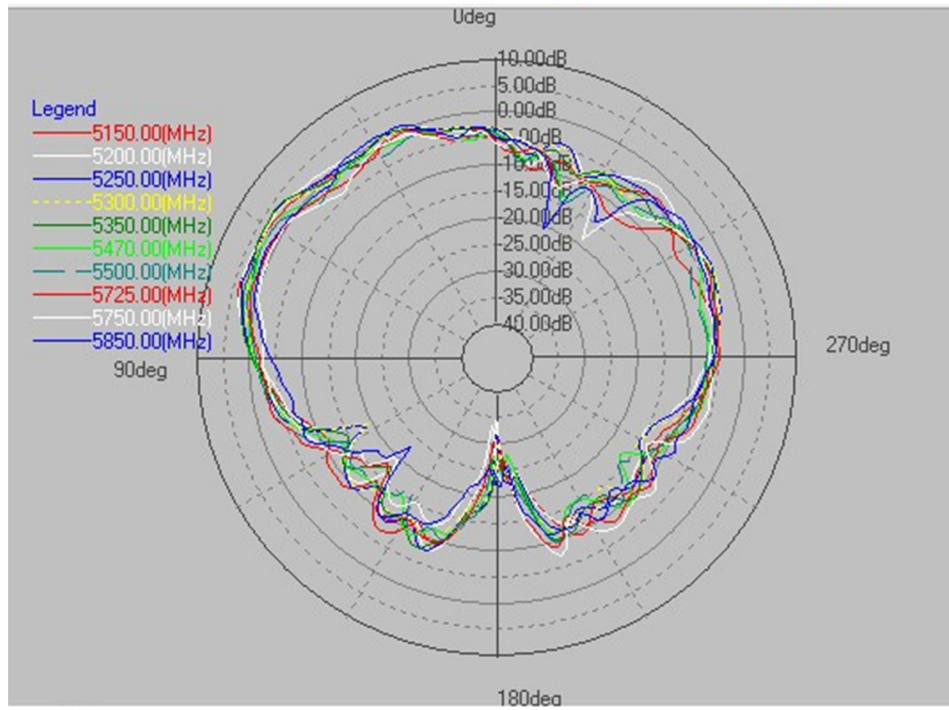

X - Y Plane (E-total)

